



★★★★★  
**REAL HYDROFIT & CO.**

SPLTS: HOSE REEL - SPRING BALANCER - HYDRAULIC HOSES & FITTINGS

# HOSE REEL - SPRING BALANCER



UDYOG AADHAAR MEMORANDUM:  
MH19B0048230



ISO 9001 :  
2015 CERTIFIED COMPANY



UDYAM REGISTRATION :  
UDYAM-MH-19-0002724

[www.realhydrofit.com](http://www.realhydrofit.com)





# ★★★★★ *REAL HYDROFIT & CO.*<sup>®</sup>

SPLTS: HOSE REEL - SPRING BALANCER - HYDRAULIC HOSES & FITTINGS

## INDEX

SR. NO.	TITLE	PG. NO.
1	Spring Balancer	1
2	Sleek Model Spring Balancer	2
3	Close Model Spring Balancer	3
4	Heavy Duty Spring Balancer	4
5	Air Tool Balancer	5
6	Static Discharge Grounding Reel	6
7	Diesel Hose Reel	7
8	Oil Hose Reel	8 - 9
9	Air Hose Reel	10 - 11
10	Grease Hose Reel	12 - 13
11	Water Hose Reel	14 - 15
12	Gas Hose Reel	16
13	Arc Hose Reel	17
14	Single Stand Hose Reel	18
15	Dual Stand Hose Reel	19
16	Oxygen Acetylene Hose Reel	20
17	Pneumatic Oil, Grease Pumps & Guns	21 - 22
18	Spring Rewind Fuel Reel	23
19	Manual or Power Rewind Hose Reel	24
20	Spring Rewind Air Hose Reel	25
21	Spring Rewind Static Discharge Reel	26
22	Spring Rewind Cable Reel	27
23	Heavy Duty Cable Reels	28
24	Impact Socket & Accessories	29
25	Bit Holder & Insert Bits	30
26	One - Touch Pneumatic Q.R.C	31
27	Hydraulic Q.R.C	32
28	Gun & Pneumatic Accessories	33
29	Tool Trolley & Accessories	34





# REAL HYDROFIT & CO.®

SPLTS: HOSE REEL - SPRING BALANCER - HYDRAULIC HOSES & FITTINGS

## SPRING BALANCER

Sleek Model Spring Balancer			Close Model Spring Balancer			Sleek Model Aluminium Spring Balancer		
Model No.	Capacity	Rope (Mtr)	Model No.	Capacity	Rope (Mtr)	Model No.	Capacity	Rope (Mtr)
RH-SB-1	0.5-1 Kg.	1.5	RH-SB-3	1-3 Kg.	1.5	640	0.4-1 Kg.	1.6
RH-SB-2	1-2 Kg.	1.5	RH-SB-3L	1-3 Kg.	2.5	641	1-2 Kg.	1.6
RH-SB-2L	1-2 Kg.	2.5	RH-SB-5	2.5-5 Kg.	1.5	642	2-3 Kg.	1.6
RH-SB-2.5	1.5-2.5 Kg.	1.5	RH-SB-5L	2.5-5 Kg.	2.5	643	2-4 Kg.	2.5
RH-SB-3.5	2.5-3.5 Kg.	1.5				644	4-6 Kg.	2.5
						645	6-8 Kg.	2.5
						646	8-10 Kg.	2.5
						647	10-14 Kg.	2.5

## ALUMINIUM DIA CASTING HEAVY DUTY SPRING BALANCER

Model No.	Capacity	Rope (Mtr)	Model No.	Capacity	Rope (Mtr)	Model No.	Capacity	Rope (Mtr)
RH-SB-09	4.5-9 Kg.	1.5	RH-SB-22	15-22 Kg.	1.7	RH-SB-85	70-85 Kg.	1.5
RH-SB-15	09-15 Kg.	1.5	RH-SB-30	22-30 Kg.	1.7	RH-SB-100	85-100 Kg.	1.5
			RH-SB-40	30-40 Kg.	1.7	RH-SB-120	100-200 Kg.	1.5
			RH-SB-50	40-50 Kg.	1.7	RH-SB-140	120-140 Kg.	1.5
			RH-SB-60	50-60 Kg.	1.7	RH-SB-170	140-170 Kg.	1.5
			RH-SB-70	60-70 Kg.	1.7	RH-SB-200	170-200 Kg.	1.5





# ★★★★★ REAL HYDROFIT & CO.®

SPLTS: HOSE REEL - SPRING BALANCER - HYDRAULIC HOSES & FITTINGS

## SLEEK MODEL SPRING BALANCER

Spring Balancer is a device that allows machinery and equipment to be suspended. The tapered drum maintains the tension even when the cable is pulled out or retrieved. As a result allow for flexible tool positioning. Workers can enjoy a more comfortable working environment with reduced weariness.



### FEATURES:

- Easy tension adjustments
- The balancer's innovative spring arrangement ensures continuous counter balance over the entire working range.
- Quick connecting & disconnecting of load.

### APPLICATIONS

- Body Shop of vehicles
- Frequent fastening screw, bolts and nuts.
- Suspending a tool for product assembly line.
- Suspending a jig, tool, welding gun etc.

### SPECIFICATION

Model No.	Rope Dia (MM)	Capacity (KG)		Working Length (MTR.)
		MIN	MAX	
RH-SB-2S	2	0.5	2	1.5
RH-SB-2M	2	0.5	2	2.0
RH-SB-2.5S	2	1.5	2.5	1.5
RH-SB-2.5M	2	1.5	2.5	2.0
RH-SB-3.5S	2	2.5	3.5	1.5
RH-SB-3.5M	2	2.5	3.5	2.0





# ★★★★★ REAL HYDROFIT & CO.®

SPLTS: HOSE REEL - SPRING BALANCER - HYDRAULIC HOSES & FITTINGS

## CLOSE MODEL SPRING BALANCER

The operator is freed from the weight of the hand tools by using an overhead Spring Balancer. The tools are suspended from one end of a wire rope looped on a spiral spring-loaded drum. When the Spring tension is adjusted properly, the tools become nearly weightless in the operator's hands and can be moved up and down with very little effort.

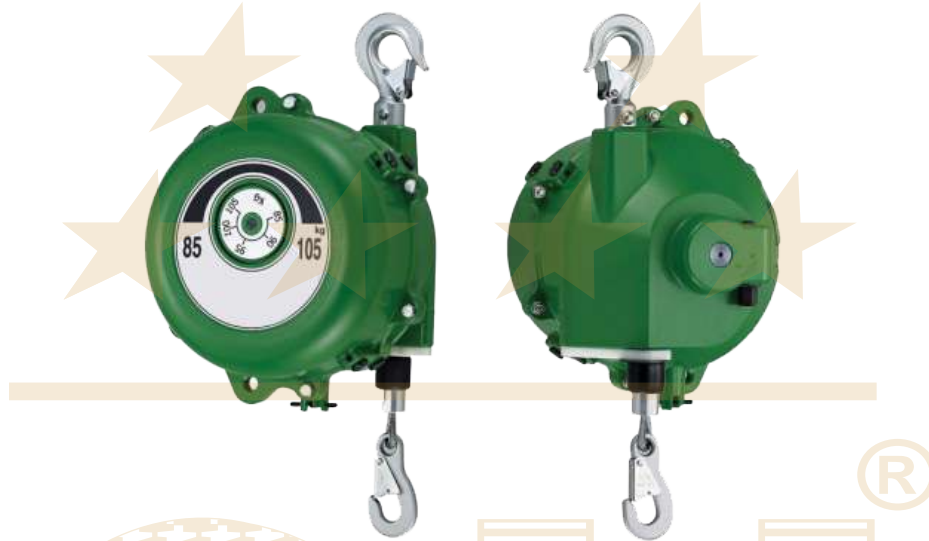

### FEATURES:

- Fully automatic Spring Rewind
- Ratchet and worm gear mechanism to give easy tension
- Sturdy Structure & Reduced Pressure Loss
- Corrosion Resistance since Powder Coated

### APPLICATIONS

- Electrical devices, jigs, tools, and materials for processed goods are suspended
- Assembly of Engines
- Body shops of vehicles
- Portable bag closing machine

### SPECIFICATION

Model No.	Rope Dia (MM)	Capacity (KG)		Working Length (MTR.)
		MIN	MAX	
RH-SB-3S	2.5	1	3	1.5
RH-SB-3M	2.5	1	3	2.5
RH-SB-3L	2.5	1	3	3.0
RH-SB-5S	2.5	2.5	5	1.5
RH-SB-5M	2.5	2.5	5	2.5
RH-SB-5L	2.5	2.5	5	3.0
RH-SB-7S	2.5	4	7	1.5
RH-SB-7M	2.5	4	7	2.5
RH-SB-7L	2.5	4	7	3.0





# ★★★★★ REAL HYDROFIT & CO.®

SPLTS: HOSE REEL - SPRING BALANCER - HYDRAULIC HOSES & FITTINGS

## HEAVY DUTY SPRING BALANCER

Spring Balancer that helps Workstations to be more efficiently organised because tools are always in the proper place. Heavy tools can be utilised in an ergonomically efficient manner with balancers, which prevent them from being dropped on the floor.

Spring Balancer used to eliminate labour, reduce idle time, increase job quality, reduce hose and cable wear, and protect people and tools from harm. A spring balancer is best suited for bench or assembly line work, with uses ranging from small tools to heavy machinery.

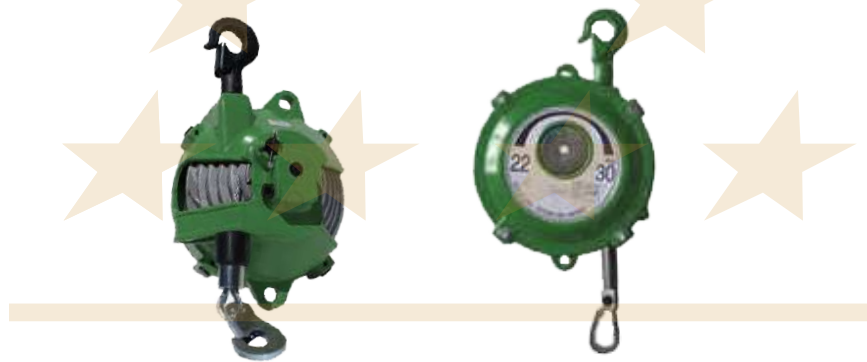

### APPLICATIONS

- Portable Drifting Attachments in Mines, Queries
- Portable Tools Link Drill Machines, Grinders, Wrenches etc.
- Assembly Line & Body Shops of vehicles.
- Pneumatic Tools Sanders, Grinders etc.

### FEATURES

- Steel Core wire rope for long life For optimal impact resistance, the enclosure is made of high-tensile aluminium pressure die casting.
- Sturdy Structure & Reduced Pressure Loss Provision of worm gear for easy tensioning.

### SPECIFICATION

Model No.	Rope Dia (MM)	Capacity (KG)		Working Length (MTR.)
		MIN	MAX	
RH-SB-9	4	4.5	9	1.3
RH-SB-15	4	9	15	1.3
RH-SB-22	5	15	22	1.5
RH-SB-30	5	22	30	1.5
RH-SB-45	5	30	45	1.5
RH-SB-60	5	45	60	1.5
RH-SB-75	5	60	75	1.5
RH-SB-90	8	75	90	1.5
RH-SB-110	8	90	110	1.5
RH-SB-140	8	110	140	1.5
RH-SB-170	8	140	170	1.5
RH-SB-200	8	170	200	1.5
RH-SB-220	8	200	220	1.5





# ★★★★★ REAL HYDROFIT & CO.®

SPLTS: HOSE REEL - SPRING BALANCER - HYDRAULIC HOSES & FITTINGS

## AIR TOOL BALANCER

This Model is best suitable for pistol type Air tool, Ideal for fastening counter. Reducing workers error and fastening troubles is coming to be important. So far, twin coil hoses are used for such an air tool. Now this new AIR TOOL BALANCER with Wire rope can be connected with an air tool directly, hang the Air Tool with wire rope and installing this equipment on the line makes the application simple. Finally coil hose problem will be cleared.

AIR TOOL BALANCER is ideal for automobiles assembling line on conveyor.

**\*Note:** AIR TOOL BALANCER is available with ratchet lock & without ratchet lock.

Model No.	Hose Size		Max Tube Length	Max Tube Pressure	Weight Capacity	
	ID MM	OD MM			Min.(kg)	Max. (kg)
RH-ATB2420	5.5	8	1.75 Mtr	12 Kg.	0.5	1.5
RH-ATB2425	6.5	10	1.75 Mtr	12 Kg.	0.5	1.5
RH-ATB2430	9	12	2 Mtr	10 Kg.	1.0	3.0
RH-ATB2431	9	12	2 Mtr	10 Kg.	2.5	5.0
RH-ATB2432	9	12	2 Mtr	10 Kg.	4.0	6.0

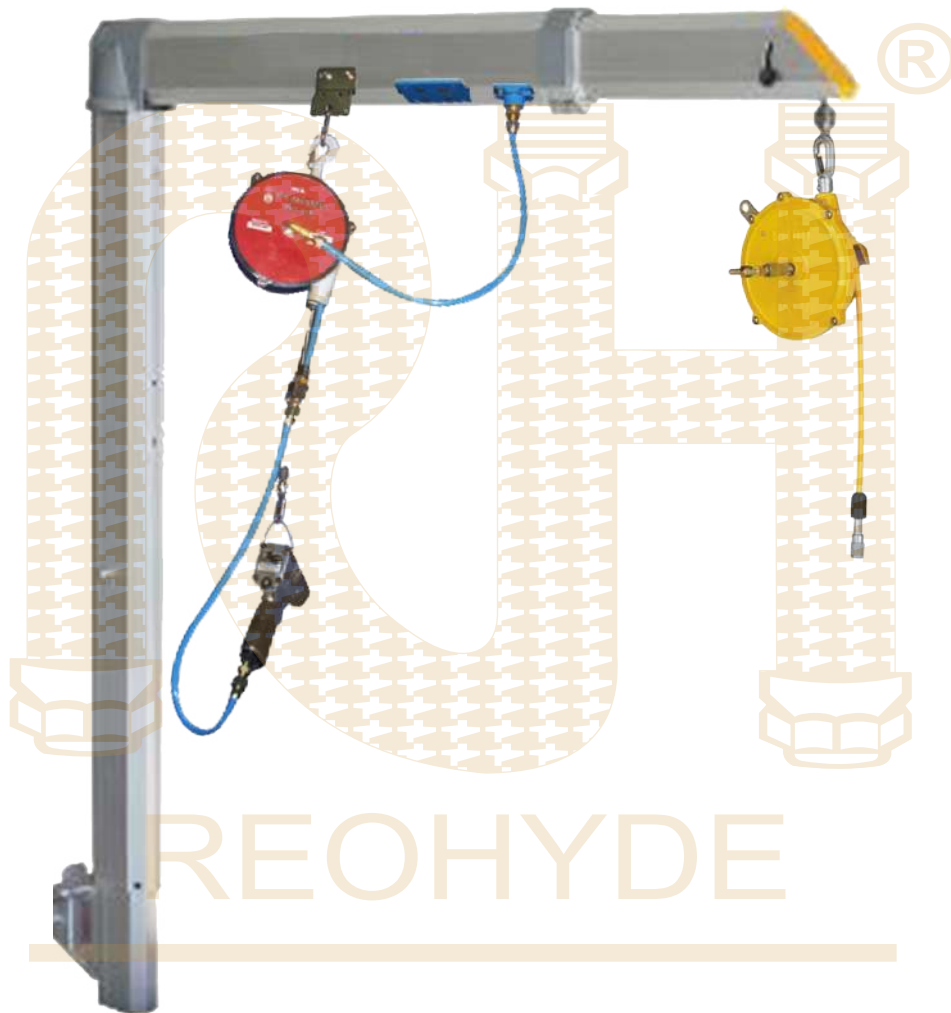



# ★★★★★ REAL HYDROFIT & CO.®

SPLTS: HOSE REEL - SPRING BALANCER - HYDRAULIC HOSES & FITTINGS

## STATIC DISCHARGE GROUNDING REEL

Static Discharge Grounding Reel Closed and compact model reels are suitable for storage of cable with quick payout and auto spring rewind. Designed for safe and reliable grounding of vehicle Fuel transfer trucks, aircraft and other equipment requiring static bonding. Reels are manufactured with mild steel & also in SS304. These reels are standard supply with 5, 10,15,20,25,30 metre of Yellow/Red PVC coated Galvanised Steel, Stainless Steel, and copper cables with single strand. Finished with powder coated in Grey, Blue, Red and Green.



### FEATURES

- Fully automatic Spring Rewind
- Reels are supplied with 4 & 6 sq.mm
- Copper wire & standard 4mm steel rope in 7x7 strand
- 100 amp Earthing ground reel

### APPLICATIONS

- Fuel Tank Loading-Unloading Static grounding
  - Air plane fuel filling
- Utility vehicle & Maintenance shop
- Any other place where static might build up

### SPECIFICATION

Model No.	Cable Length (Mtr.)	Material Of Construction
RH-SDR-05-CS	05	Carbon Steel with Powder Coated
RH-SDR-10-CS	10	Carbon Steel with Powder Coated
RH-SDR-15-CS	15	Carbon Steel with Powder Coated
RH-SDR-20-CS	20	Carbon Steel with Powder Coated
RH-SDR-25-CS	25	Carbon Steel with Powder Coated
RH-SDR-30-CS	30	Carbon Steel with Powder Coated
RH-SDR-05-CS	05	Stainless Steel 304
RH-SDR-10-CS	10	Stainless Steel 304
RH-SDR-15-CS	15	Stainless Steel 304
RH-SDR-20-CS	20	Stainless Steel 304
RH-SDR-25-CS	25	Stainless Steel 304
RH-SDR-30-CS	30	Stainless Steel 304

**CABLE DETAILS :** 1C X 4 & 6 sq.mm COPPER & SINGLE 7 X 7 STRANDED STEEL



sales@realhydrofit.com  
reohydesales@gmail.com



www.realhydrofit.com



9869078630, 9167921882  
91 22 66573951/52/53, 23717488



# ★★★★★ REAL HYDROFIT & CO.®

SPLTS: HOSE REEL - SPRING BALANCER - HYDRAULIC HOSES & FITTINGS

## DIESEL HOSE REEL

Spring Rewind Diesel Hose Reel that offers a twin pedestal designs to provide ultimate performance and reliability. Bright Industries offer a wide range of Diesel Fuel Hose Reels in a variety of sizes that come with an option of with or without hose according to the customer requirement.

Real Hydrofit Retractable Diesel Hose Reel supply standard range of hose reel ideal for your application. Real Hydrofit Diesel Hose Reel range includes high capacity versions for refueling vehicles that cannot gain immediate access to the tank. Our diesel fuel hose reel also offers to keep the working environment compactly clean and sophisticated.

### FEATURES

- Fully automatic Spring Rewind
- Brake system is Supplied with spring actuated pin lock as standard
- Sturdy Structure & Reduced Pressure Loss
- Corrosion Resistance Since powder Coated

### APPLICATIONS

- Safe Fuel delivery to required system
  - Refueling tank
- Standard Use in Diesel Bowser
  - Mobile detailing Vehicles
- Any industry where hoses are kept in chaotic way

### SPECIFICATION

Model No.	Hose Size ID	Hose Length (mtr.)	Max Working Pressure (Bar)
RH-DR-3405	3/4"	05	20
RH-DR-3410	3/4"	10	20
RH-DR-3415	3/4"	15	20
RH-DR-3420	3/4"	20	20
RH-DR-3425	3/4"	25	20
RH-DR-3430	3/4"	30	20
RH-DR-1005	1"	05	20
RH-DR-1010	1"	10	20
RH-DR-1015	1"	15	20
RH-DR-1020	1"	20	20
RH-DR-1025	1"	25	20
RH-DR-1030	1"	30	20
RH-DR-11210	1 1/2"	10	20
RH-DR-11215	1 1/2"	15	20

**Note:** We also Makes Manual as well as Customized Diesel Hose Reel according to the customer Requirement.





★★★★★  
**REAL HYDROFIT & CO.**<sup>®</sup>  
SPLTS: HOSE REEL - SPRING BALANCER - HYDRAULIC HOSES & FITTINGS

## OIL HOSE REEL

Automatic Oil hose reels specially designed to work to high oil pressures and flow rate. Our Oil hose reels rapidly become the Workshop Managers choice due to its track record of trouble-free operation. This Reduce clutter and increase workplace safety with hose reels designed for everyday use in service garages, shops and dealerships.

With its durable high grade metal construction with powder coating on it improves strength and with rigid dual pedestal frame increases its performance, Our hose reels are built to last. We produce each range of Oil hose reel that is used in different industries for various application.

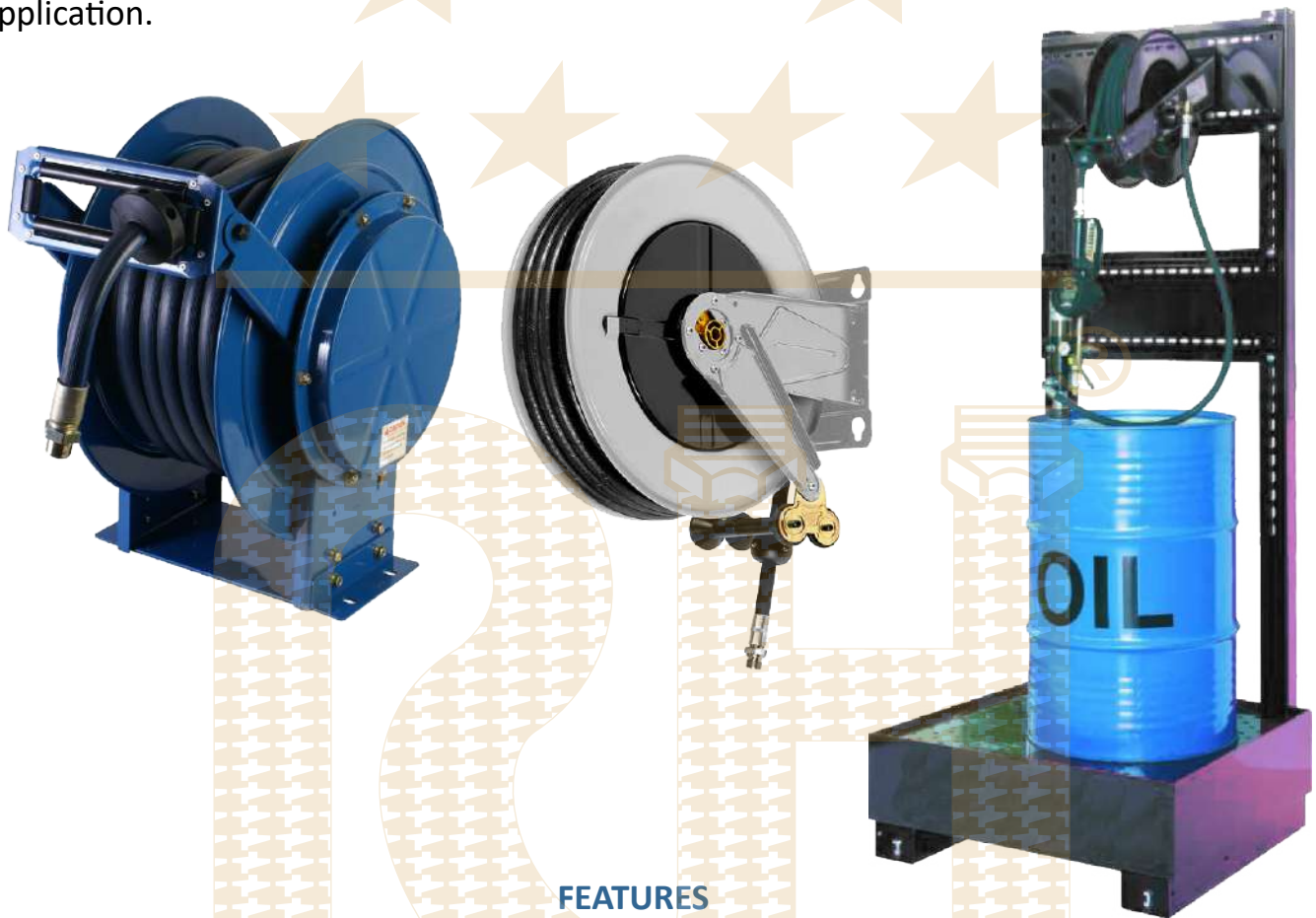

### FEATURES

- Spring driven Retractable hose reel
  - The hose can be locked at the desired length
- Different Mounting arms enables floor, roof, wall or tank mounting
  - Increased strength due to Dual Pedestal frame

### APPLICATIONS

- For Garage Equipment
  - Construction & Fleet maintenance
- Transfer of oil in various Industrial Applications
  - Mining & Logistics Industries
  - Service Vehicle



[sales@realhydrofit.com](mailto:sales@realhydrofit.com)  
[reohydesales@gmail.com](mailto:reohydesales@gmail.com)



[www.realhydrofit.com](http://www.realhydrofit.com)



9869078630, 9167921882  
91 22 66573951/52/53, 23717488



# REAL HYDROFIT & CO.®

SPLTS: HOSE REEL - SPRING BALANCER - HYDRAULIC HOSES & FITTINGS

## OIL HOSE REEL SPECIFICATION

### Open Model

### Close Model

Model No.	Hose Size ID	Hose Length (mtr.)	Max Press. (Bar)	Model No.	Rope Dia (MM)	Hose Length (mtr.)	Max Press. (Bar)
RH-OR-1410	1/4"	10	300	RH-OR-C1410	1/4"	10	300
RH-OR-1415	1/4"	15	300	RH-OR-C1415	1/4"	15	300
RH-OR-1420	1/4"	20	300	RH-OR-C1420	1/4"	20	300
RH-OR-1425	1/4"	25	300	RH-OR-C3810	3/8"	10	240
RH-OR-1430	1/4"	30	300	RH-OR-C3815	3/8"	15	240
RH-OR-1410	3/8"	10	240	RH-OR-C3820	3/8"	20	240
RH-OR-1415	3/8"	15	240	RH-OR-C1210	1/2"	10	200
RH-OR-1420	3/8"	20	240	RH-OR-C1215	1/2"	15	200
RH-OR-1425	3/8"	25	240	RH-OR-C1220	1/2"	20	200
RH-OR-1430	3/8"	30	240				
RH-OR-1410	1/2"	10	200				
RH-OR-1415	1/2"	15	200				
RH-OR-1420	1/2"	20	200				
RH-OR-1425	1/2"	25	200				
RH-OR-1430	1/2"	30	200				
RH-OR-1410	3/4"	10	140				
RH-OR-1415	3/4"	15	140				
RH-OR-1420	3/4"	20	140				
RH-OR-1425	3/4"	25	140				
RH-OR-1430	3/4"	30	140				
RH-OR-1410	1"	10	110				
RH-OR-1415	1"	15	110				
RH-OR-1420	1"	20	110				
RH-OR-1425	1"	25	110				
RH-OR-1430	1"	30	110				

### HEAVY DUTY OIL HOSE REEL MODEL

Model No.	Hose Size ID	Hose Length (mtr.)	Max Press. (Bar)
RH-OR-11410	1-1/4"	10	90
RH-OR-11415	1-1/4"	15	90
RH-OR-11410	1-1/2"	10	70
RH-OR-11415	1-1/2"	15	70
RH-OR-11410	2"	10	50



**Note:** We also Makes Manual as well as Customized Oil Hose Reel according to the Customer Requirement.





★★★★★  
**REAL HYDROFIT & CO.**<sup>®</sup>  
SPLTS: HOSE REEL - SPRING BALANCER - HYDRAULIC HOSES & FITTINGS

## AIR HOSE REEL

Fully retractable Air Hose Reel with permanently lobed springs, self-locking safety latch, rugged and corrosion resistant finish.

Air Hose Reels are durable and compact for a wide range of applications with critical space requirements. A full flow shaft and swivel assures maximum product delivery.

Air Hose Reels mountable on floors, walls, ceilings, workbenches or inside your Vehicle. This drum incorporates a powerful torsion spring to ensure a positive movement of the hose when being pulled out or retracted. According to the application and requirement we can supply open as well as closed model with manual operated, with auto rewind function, with motor operated model which covers all ideal and customized air hose reels. Leveraging the skills of our qualified team of professionals, we are instrumental in offering wide range of Auto Rewind Air Hose Reel.

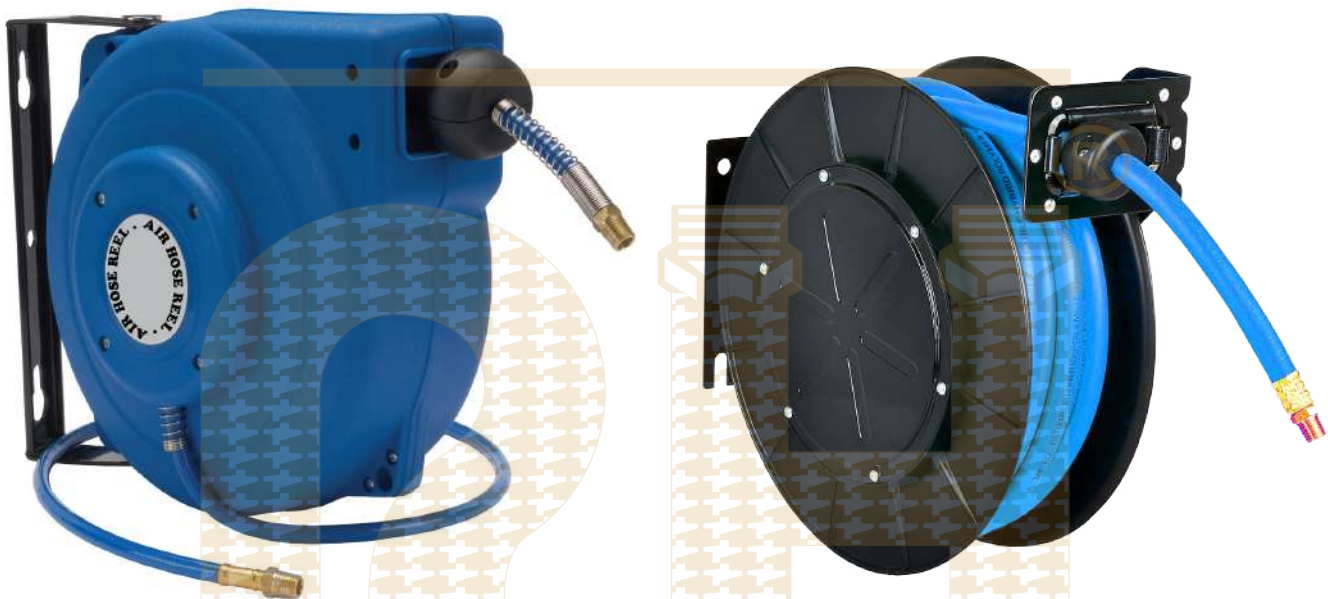

### FEATURES

- Spring driven Retractable Hose reel
- The hose can be locked at the desired length
- Easy and versatile installation through bracket pivots
- Rugged and corrosion resistant finish

### APPLICATIONS

- Pneumatic Air Tools
  - Tire Services
- Decontamination & Misc. Compressed Air Delivery
- Pressurized Air for Air Blow Guns in Car Services
  - Service Bays / Garages / Paint Spraying



[sales@realhydrofit.com](mailto:sales@realhydrofit.com)  
[reohydesales@gmail.com](mailto:reohydesales@gmail.com)



[www.realhydrofit.com](http://www.realhydrofit.com)



9869078630, 9167921882  
91 22 66573951/52/53, 23717488



# REAL HYDROFIT & CO.®

SPLTS: HOSE REEL - SPRING BALANCER - HYDRAULIC HOSES & FITTINGS

## AIR HOSE REEL



### SPECIFICATION

#### Close Model

#### Open Model

Model No.	Hose Size IDxOD (mm)	Hose Length (mtr.)	Max Press. (Bar)
RH-AR-5810	5.5 x 8	10	10
RH-AR-5815	5.5 x 8	15	10
RH-AR-5820	5.5 x 8	20	10
RH-AR-5825	5.5 x 8	25	10
RH-AR-8125	8 x 12	4.5	10
RH-AR-81210	8 x 12	10	10
RH-AR-81215	8 x 12	15	10
RH-AR-81220	8 x 12	20	10
RH-AR-81225	8 x 12	25	10
RH-AR-81230	8 x 12	30	10
RH-AR-101410	10 x 14	10	10
RH-AR-101415	10 x 14	15	10
RH-AR-101420	10 x 14	20	10
RH-AR-101425	10 x 14	25	10
RH-AR-101430	10 x 14	30	10
RH-AR-121610	12 x 16	10	10
RH-AR-121615	12 x 16	15	10
RH-AR-121620	12 x 16	20	10
RH-AR-121625	12 x 16	25	10

Model No.	Hose Size ID	Hose Length (mtr.)	Max Press. (Bar)
RH-AR-1410	1/4"	10	30
RH-AR-1415	1/4"	15	30
RH-AR-1420	1/4"	20	30
RH-AR-1425	1/4"	25	30
RH-AR-1430	1/4"	30	30
RH-AR-3810	3/8"	10	30
RH-AR-3815	3/8"	15	30
RH-AR-3820	3/8"	20	30
RH-AR-3825	3/8"	25	30
RH-AR-3830	3/8"	30	30
RH-AR-1210	1/2"	10	30
RH-AR-1215	1/2"	15	30
RH-AR-1220	1/2"	20	30
RH-AR-1225	1/2"	25	30
RH-AR-1230	1/2"	30	30

**Note:** We also makes manual as well as customized Air Hose Reel according to the customer requirement.





★★★★★  
**REAL HYDROFIT & CO.**®

SPLTS: HOSE REEL - SPRING BALANCER - HYDRAULIC HOSES & FITTINGS

## GREASE HOSE REEL

Spring Driven retractable Grease Hose Reel with durability, performance and value built into every reel. The Grease Hose Reel is specifically designed for use in garage and workshop applications. Garage and workshops often require Grease Hose Reels with a long length of hose that they can pull out to dispense the fluid at multiple bays around the workshop. Our range of Grease Hose Reels includes open and enclosed reels in a variety of different lengths and with or without hose. We also offer high capacity Grease hose reels for applications where a longer length of hose is required.

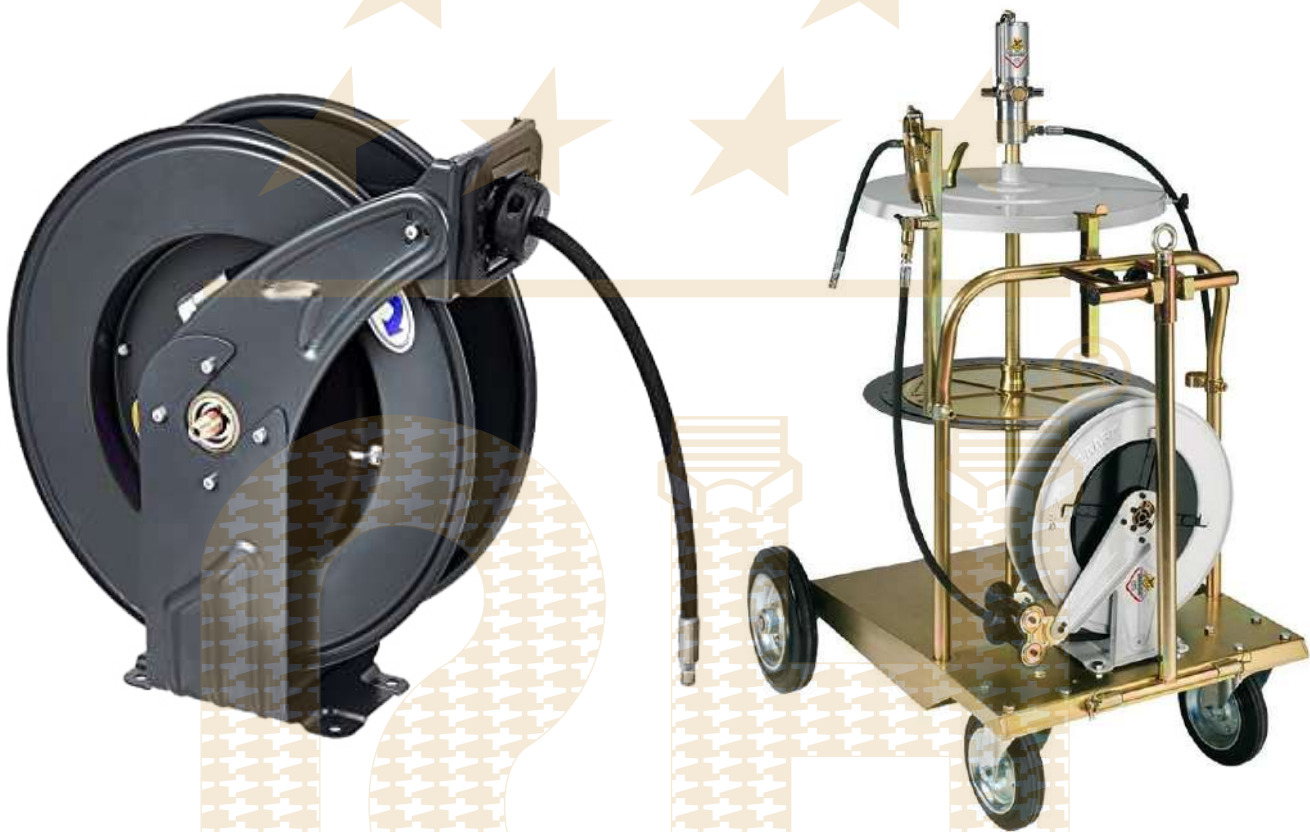

### FEATURES

- Fully automatic Spring Rewind
- Brake system is Supplied with spring actuated pin lock as standard
- Sturdy Structure & Reduced Pressure Loss
- Corrosion Resistance Since powder Coated

### APPLICATIONS

- Quick Lube Stations
- Fleet Truck Maintenance
- Manufacturing / Fabrication Shops
- Mobile detailing Vehicles
- Auto Mobile servicing center



[sales@realhydrofit.com](mailto:sales@realhydrofit.com)  
[reohydesales@gmail.com](mailto:reohydesales@gmail.com)



[www.realhydrofit.com](http://www.realhydrofit.com)



9869078630, 9167921882  
91 22 66573951/52/53, 23717488



# REAL HYDROFIT & CO.®

SPLTS: HOSE REEL - SPRING BALANCER - HYDRAULIC HOSES & FITTINGS

## GREASE HOSE REEL

### SPECIFICATION

#### Open Model

#### Close Model

Model No.	Hose Size IDxOD (mm)	Hose Length (mtr.)	Max Press. (Bar)	Model No.	Hose Size ID	Hose Length (mtr.)	Max Press. (Bar)
RH-GR-1410	1/4"	10	400	RH-GR-C1410	1/4"	10	400
RH-GR-1415	1/4"	15	400	RH-GR-C1415	1/4"	15	400
RH-GR-1420	1/4"	20	400	RH-GR-C1420	1/4"	20	400
RH-GR-1425	1/4"	25	400	RH-GR-C3810	3/8"	10	330
RH-GR-1430	1/4"	30	400	RH-GR-C3815	3/8"	15	330
RH-GR-3810	3/8"	10	330	RH-GR-C3820	3/8"	20	330
RH-GR-3815	3/8"	15	330	RH-GR-C1210	1/2"	10	280
RH-GR-3820	3/8"	20	330	RH-GR-C1215	1/2"	15	280
RH-GR-3825	3/8"	25	330	RH-GR-C1220	1/2"	20	280
RH-GR-3830	3/8"	30	330				
RH-GR-1210	1/2"	10	280				
RH-GR-1215	1/2"	15	280				
RH-GR-1220	1/2"	20	280				
RH-GR-1225	1/2"	25	280				
RH-GR-1230	1/2"	30	280				

**Note:** We also makes manual as well as customized Grease Hose Reel according to the customer requirement.





★★★★★  
**REAL HYDROFIT & CO.**<sup>®</sup>  
SPLTS: HOSE REEL - SPRING BALANCER - HYDRAULIC HOSES & FITTINGS

## WATER HOSE REEL

Auto-Rewind Water Hose Reel which are built with high standard quality and attention to material to provide high performances.

You get a professional look, easier fit and faster performing equipment. The spring loaded tension enables the reel to automatically self-retract hose without the need for external power - which makes them a great cost-effective alternative to motor driven reels. Multi-position lock ratchet mechanism secures the hose at the desired length. Water Hose Reel includes wide range of hose reel suitable for all industrial and commercial application.

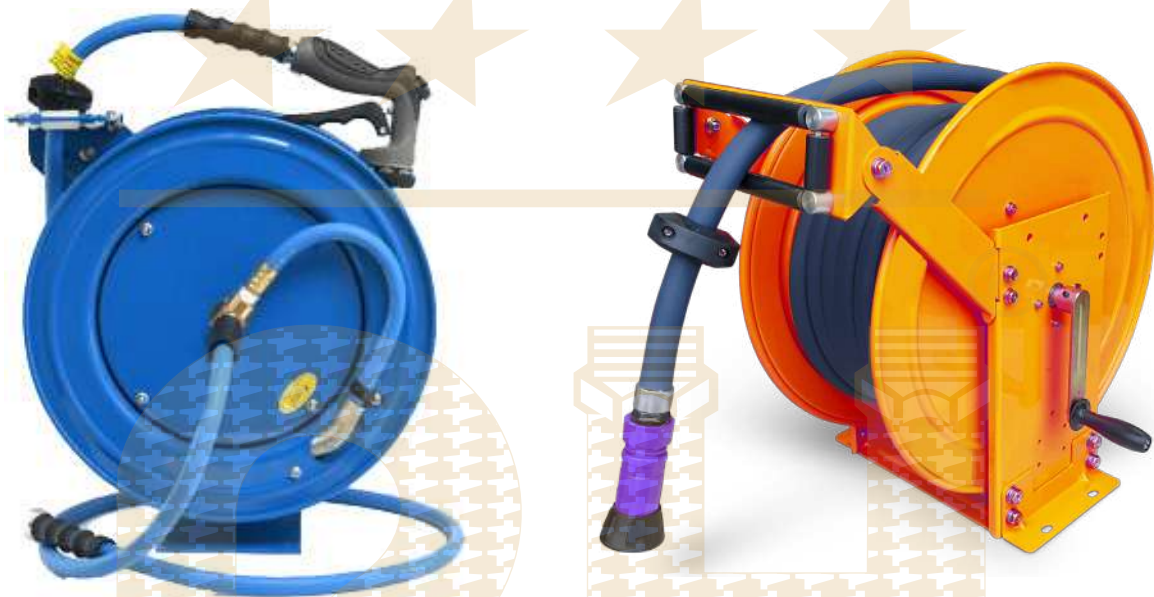

### FEATURES:

- Increased frame strength with dual pedestal frame
- Brake system is Supplied with spring actuated pin lock
  - Sturdy Structure & Reduced Pressure Loss
  - Corrosion Resistance Since powder Coated

### APPLICATIONS

- Automobile Service Station
- Construction Industries
- Chemical Industries
- Mobile detailing Vehicles
- Manufacturing & Agriculture Industries



[sales@realhydrofit.com](mailto:sales@realhydrofit.com)  
[reohydesales@gmail.com](mailto:reohydesales@gmail.com)



[www.realhydrofit.com](http://www.realhydrofit.com)



9869078630, 9167921882  
91 22 66573951/52/53, 23717488



# REAL HYDROFIT & CO.®

SPLTS: HOSE REEL - SPRING BALANCER - HYDRAULIC HOSES & FITTINGS

## WATER HOSE REEL SPECIFICATION

### OPEN MODEL

### CLOSE MODEL

Model No.	Hose Size IDxOD (mm)	Hose Length (mtr.)	Max Press. (Bar)
RH-WR-1410	1/4"	10	30
RH-WR-1415	1/4"	15	30
RH-WR-1420	1/4"	20	30
RH-WR-1425	1/4"	25	30
RH-WR-1430	1/4"	30	30
RH-WR-3810	3/8"	10	30
RH-WR-3815	3/8"	15	30
RH-WR-3820	3/8"	20	30
RH-WR-3825	3/8"	25	30
RH-WR-3830	3/8"	30	30
RH-WR-1210	1/2"	10	30
RH-WR-1215	1/2"	15	30
RH-WR-1220	1/2"	20	30
RH-WR-1225	1/2"	25	30
RH-WR-1230	1/2"	30	30
RH-WR-3410	3/4"	10	30
RH-WR-3415	3/4"	15	30
RH-WR-3420	3/4"	20	30
RH-WR-3425	3/4"	25	30
RH-WR-3430	3/4"	30	30
RH-WR-0110	1"	10	30
RH-WR-0115	1"	15	30
RH-WR-0120	1"	20	30
RH-WR-0125	1"	25	30
RH-WR-0130	1"	30	30

Model No.	Hose Size ID	Hose Length (mtr.)	Max Press. (Bar)
RH-WR-C1410	1/4"	10	30
RH-WR-C1415	1/4"	15	30
RH-WR-C1420	1/4"	20	30
RH-WR-C3810	3/8"	10	30
RH-WR-C3815	3/8"	15	30
RH-WR-C3820	3/8"	20	30
RH-WR-C1210	1/2"	10	30
RH-WR-C1215	1/2"	15	30
RH-WR-C1220	1/2"	20	30

### HEAVY DUTY WATER HOSE REEL MODEL

Model No.	Hose Size ID	Hose Length (mtr.)	Max Press. (Bar)
RH-WR-11410	1-1/4"	10	30
RH-WR-11415	1-1/4"	15	30
RH-WR-11210	1-1/2"	10	30
RH-WR-11215	1-1/2"	15	30
RH-WR-0210	2"	10	30



**Note:** Real Hydrofit also Makes Manual as well as Customized Water Hose Reel according to the Customer Requirement.





# REAL HYDROFIT & CO.®

SPLTS: HOSE REEL - SPRING BALANCER - HYDRAULIC HOSES & FITTINGS

## GAS HOSE REEL

Gas Hose Reel offer a twin pedestal designs to provide ultimate performance and reliability. Retractable Gas Hose Reel is a professional device that helps to handle the oxygen and LPG(or acetylene gas) containers safely at work sites and prevents negligent accidents.

A wide range of Gas Hose Reels are available in a variety of sizes that come with an option of with or without hose reel trolley according to the customer requirement. The open structure allows an easy assembly and replacement of the hose and the control of the rewinding.

### FEATURES

- The sturdy "U" shaped frame and all steel construction make this one tough little reel
  - Save time and effort while increasing the safety of your work environment
    - Sturdy Structure & Reduced Pressure Loss
    - Corrosion Resistance Since powder Coated

### APPLICATIONS

- Welding Oxy Acetylene Gas
- Manufacturing / Fabrication Shops
- Aviation / Aerospace Manufacturing
- Railroad / Bridges/ Shipyards
- Welding Carts



**AUTO-REWIND**

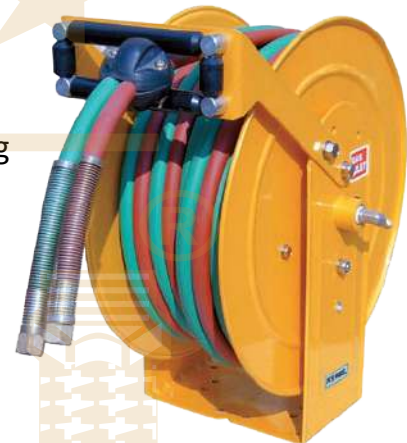

**MANUAL-REWIND**

### SPECIFICATION

Model No.	Hose Size ID(MM)	Hose Length (mtr.)	Hose Material	Model No.	Hose Size ID(MM)	Hose Length (mtr.)	Hose Material
RH-OAR-0610	6	10	Rubber	RH-OAR-M0610	6	10	Rubber
RH-OAR-0810	8	10	Rubber	RH-OAR-M0810	8	10	Rubber
RH-OAR-0615	6	15	Rubber	RH-OAR-M0620	6	20	Rubber
RH-OAR-0815	8	15	Rubber	RH-OAR-M0820	8	20	Rubber
RH-OAR-0620	6	20	Rubber	RH-OAR-M0630	6	30	Rubber
RH-OAR-0820	8	20	Rubber	RH-OAR-M0830	8	30	Rubber
RH-OAR-0625	6	25	Rubber	RH-OAR-M0640	6	40	Rubber
RH-OAR-0825	8	25	Rubber	RH-OAR-M0840	8	40	Rubber
RH-OAR-0630	6	30	Rubber	RH-OAR-M0650	6	50	Rubber
RH-OAR-0830	8	30	Rubber	RH-OAR-M0850	8	50	Rubber

**Note:** Real Hydrofit also Makes Manual as well as Customized Gas Hose Reel according to the Customer Requirement.



[sales@realhydrofit.com](mailto:sales@realhydrofit.com)  
[reohydesales@gmail.com](mailto:reohydesales@gmail.com)



[www.realhydrofit.com](http://www.realhydrofit.com)



9869078630, 9167921882  
 91 22 66573951/52/53, 23717488



# ★★★★★ REAL HYDROFIT & CO.®

SPLTS: HOSE REEL - SPRING BALANCER - HYDRAULIC HOSES & FITTINGS

## ARC WELDING REEL

We offer professional grade Arc Welding Reel in spring driven, hand crank, or motorized retraction methods that can handle varying lengths of cable from standard lengths to high capacity depending on the cable required. Arc welding reels are the perfect solution to increase efficiency at the worksite by keeping cable off the ground and tidy, which drastically decreases tripping hazards. You will also extend the life of your cables by preventing premature wear and increase ease of use by keeping your welding electrode accessible, to be pulled out on the fly. Ensure protection of your expensive welding equipment by having a solid grounding solution that enhances ease of use, thanks to our reels; which, by the way, are easily mountable in shops, trucks or trailers, or on portable welding cart units.

### FEATURES

- Reels are all steel construction and compact design
  - Quick connection to your welder.
- Declutching arbor is provided to prevent damage from reverse winding.
  - Sturdy Structure & Reduced Pressure Loss
  - Corrosion Resistance Since powder Coated



### APPLICATIONS

- Aviation / Aerospace / Airports
  - Service Bays / Garages
- Manufacturing / Fabrication Shops
  - Highway & Street Equipment
  - Railroad / Bridges/ Shipyards
    - Welding Carts



### Auto-Rewind

Model No.	Cable Specifications	Cable Length (mtr)	Allowable Current (Amp)
RH-AWR-2520	25SQMM X 1C X WELDING HOLDER	20	200
RH-AWR-2530	25SQMM X 1C X WELDING HOLDER	30	200
RH-AWR-3520	35SQMM X 1C X WELDING HOLDER	20	300
RH-AWR-3530	35SQMM X 1C X WELDING HOLDER	30	300
RH-AWR-7020	70SQMM X 1C X WELDING HOLDER	20	500

### Manual-Rewind

Model No.	Cable Specifications	Cable Length (mtr)	Allowable Current (Amp)
RH-AWR-2520	25SQMM X 1C X WELDING HOLDER	20	200
RH-AWR-2530	25SQMM X 1C X WELDING HOLDER	30	200
RH-AWR-3520	35SQMM X 1C X WELDING HOLDER	20	300
RH-AWR-3530	35SQMM X 1C X WELDING HOLDER	30	300
RH-AWR-7020	70SQMM X 1C X WELDING HOLDER	20	500

**Note:** Real Hydrofit also Makes Manual as well as Customized Arc Hose Reel according to the Customer Requirement.





# REAL HYDROFIT & CO.®

SPLTS: HOSE REEL - SPRING BALANCER - HYDRAULIC HOSES & FITTINGS

## SINGLE STAND HOSE REEL

### SPRING REWIND HOSE REEL

**SERIES - 7000**

**FOR: - AIR, WATER, OIL, GREASE.**

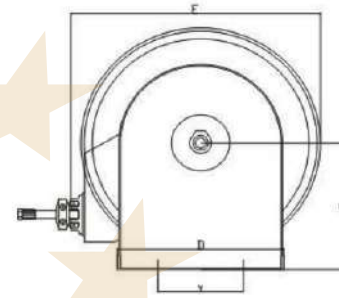
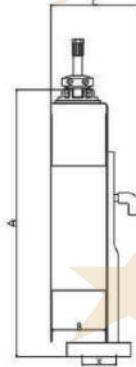

- Single Stand Steel Frame Construction.
- Hose Reels are made of heavy guage, high quality steel fabricated and compact design.
- The sturdy all welded frame base provides extra strength to handle the extra weight without losing performance.
- High-Quality Spring for long-life of Coil spring, SS ratchet spring & non-corrosive ratchet.
- Full-Flow Shaft and Swivel Rotary to Maximize Fluid flow with minimum pressure drop for faster fills.
- Standard Swivel inlet: 90° with 1/2" bsp male thread size & outlet 1/2" bsp male.
- Swivel Rotary Seal - PU Seal
- Multi-Position Lock Ratchet Secures Hose at desired length
- Final Finishing / Painting: powder coated as standard red colour. (Other colour are available upon requested)
- All materials is carbon steel as standard.
- Standard working pressure 200 bar. (available upto 550 bar)
- 2 Years manufacturers waranty.

#### APPLICATION

- Manufacturing industry in all sector for pneumatic tool, assembly line and other general industrial operations.
- Municipal Corporations, Garage Workshops for lubrication, washing
- Oil management systems for multi point.

Model No. For Spring Rewind	Hose Size & Length				Net Wt.	REEL DIMENSION							
	I.D.	6.4mm	9.5mm	12.7mm		A	B	C	D	E	F	X	Y
	O.D.	13.2mm	17.2mm	20.2mm									
OMP-7-141205		10 mtr	10 mtr	5 mtr		384	100	220	270	435	215	80	220
OMP-7-141210		15 mtr	15 mtr	10 mtr		406	100	220	300	500	245	120	210
OMP-7-141215		20 mtr	20 mtr	15 mtr		568	100	220	300	560	270	120	220
OMP-7-141220		25 mtr	25 mtr	20 mtr		568	130	250	300	560	270	120	220

**NOTICE:** A flexible connector must be used between the inlet pipe and the inlet swivel joint.



sales@realhydrofit.com  
reohydesales@gmail.com



www.realhydrofit.com



9869078630, 9167921882  
91 22 66573951/52/53, 23717488



# ★★★★★ REAL HYDROFIT & CO.®

## DUAL STAND HOSE REEL HEAVY DUTY SPRING REWIND HOSE REEL



**SERIES - 8000**

**FOR: - AIR, WATER, OIL, HYDRAULIC, GREASE.**

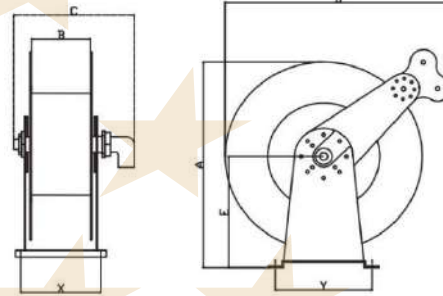

- Double Stand Steel Frame Construction.
- All Hose Reels are made of heavy gauge, high quality steel fabricated and compact design.
- The sturdy all welded frame base provides extra strength to handle the extra weight without losing performance, More suitable in mobile applications.
- Dual frame, guide plate and 4-way roller assembly.
- High-Quality Spring for long-life of Coil spring, SS ratchet spring & non-corrosive ratchet.
- Full-Flow Shaft and Swivel Rotary to Maximize Fluid flow with minimum pressure drop for faster fills.
- Standard Swivel inlet: 90° with 1/2" bsp male thread size & outlet 1/2" bsp male.
- Swivel Rotary Seal - PU Seal
- Multi-Position Lock Ratchet Secures Hose at desired length
- Final Finishing / Painting: powder coated as standard red colour. (Other colour are available upon requested)
- All materials is carbon steel as standard.(Stainless hose reels materials are available upon requested)
- Standard working pressure 200 bar. (available upto 690 bar)
- 2 Years manufacturers warranty.

### APPLICATION

- Manufacturing industry in all sector.
- Municipal Corporations, Garage Workshops.
- Oil management systems.
- Mobile service van.

Model No. For Spring Rewind	Hose Size & Length				Net Wt.	REEL DIMENSION						
	I.D.	6.4mm	9.5mm	12.7mm		A	B	C	D	E	X	Y
	O.D.	13.2mm	17.2mm	20.2mm								
OMP-8-141205		10 mtr	10 mtr	5 mtr		400	100	225	401	225	120	200
OMP-8-141210		15 mtr	15 mtr	10 mtr		475	100	225	471	260	120	240
OMP-8-141215		20 mtr	20 mtr	15 mtr		520	100	225	500	290	120	240
OMP-8-141220		25 mtr	25 mtr	20 mtr		520	130	255	500	290	150	240
OMP-8-141225		30 mtr	30 mtr	25 mtr		520	170	295	500	290	175	240
OMP-8-141230		----	----	30 mtr		590	170	295	550	325	175	240

**NOTICE:** A flexible connector must be used between the inlet pipe and the inlet swivel joint.

- Reel Dimension are subject to change.
- X & Y Indicates Mounting holes.





# ★★★★★ REAL HYDROFIT & CO.®

SPLTS: HOSE REEL - SPRING BALANCER - HYDRAULIC HOSES & FITTINGS

## OXYGEN-ACETYLENE HOSE REEL

Designed to be used at work sites where the movable container of oxygen, LPG, Acetylene and etc. are being handled. Able to load any kinds of above-listed gas container also designed to never be fallen down, leakproof even on the maximum pressure (15kg/cm<sup>2</sup>) and on the lowest pressure.

### OXYGEN-ACETYLENE HOSE REEL

Art No.	Model No.	Hose			W/P
		Material	ID(MM)	Length/mtr	
620	RH 620	Rubber Hose	6	upto 30	10
620	RH 820	Rubber Hose	8	upto 30	10
808	RH 815	Rubber Hose	6	15	10
808	RH 820	Rubber Hose	8	20	10



## OIL DISTRIBUTION UNIT

Three seats Oil distribution unit, composed by:

- 3 No. pneumatic pumps R. 3:1
- 3 No. pump adaptors for drums
- 3 No. automatic hose reels
- 3 No. rubber hoses L. 10 mt, ½"
- 3 No. connection hose L. 2 mt
- 3 No. digital oil meter guns
- 3 No. no-spillage brackets
- 3 seats cabinet



## SPRING REWIND CLOSED HOSE REEL

Model No. For Spring Rewing	I.D.	Hose Size & Length			Net Wt.	Reel Dimension							
	O.D.	6.4 mm	9.5 mm	12.7 mm		A	B	C	D	E	F	X	Y
		13.2 mm	17.2 mm	20.2 mm									
OMP-9-141205		10 mtr	10 mtr	5 mtr		415	145	220	386	446	218	120	420
OMP-9-141210		15 mtr	15 mtr	10 mtr		500	130	225	460	520	265	130	500
OMP-9-141215		20 mtr	20 mtr	15 mtr		530	165	240	515	580	292	150	555
OMP-9-141220		25 mtr	22 mtr	20 mtr		530	215	290	515	580	292	205	555

**NOTICE:** A flexible connector must be used between the inlet pipe and the inlet swivel joint.

- Reel Dimension are subject to change.
- X & Y Indicates Mounting holes.

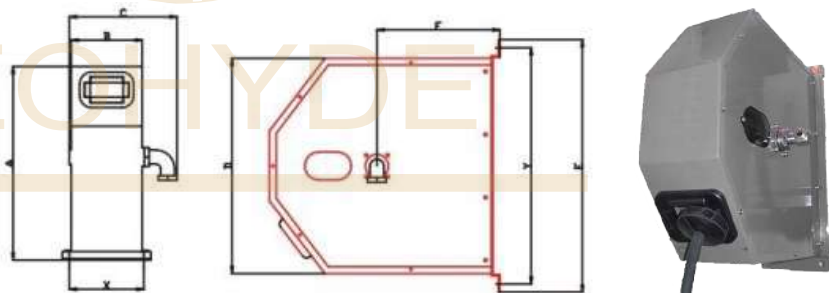

sales@realhydrofit.com  
reohydesales@gmail.com



www.realhydrofit.com



9869078630, 9167921882  
91 22 66573951/52/53, 23717488



# ★★★★★ REAL HYDROFIT & CO.®

SPLTS: HOSE REEL - SPRING BALANCER - HYDRAULIC HOSES & FITTINGS

## PNEUMATIC OIL, GREASE PUMPS & GUNS AIR OPERATED GREASE PUMPS



Pneumatic Pumps for Grease dispensing at short distance, Output Pressure 400 bar at Min.2 - Max.8 bar Air Pressure, Compression Ratio 50:1, Pumps available for Drums.

### Art No. 4180

Capacity	Art No.	Flow Rate	Air consumption
16-18 Kg.	4118	1.36 Kg./Min	115 L/Min.
20-30 Kg.	4120	1.36 Kg./Min	115 L/Min.
50-60 Kg.	4160	1.36 Kg./Min	115 L/Min.
180 Kg.	4180	1.36 Kg./Min	115 L/Min.

Pneumatic Pumps for Grease dispensing at short distance, Output Pressure 800 bar at Min.2-Max.8 bar Air Pressure, Compression Ratio 100:1, Pumps available for Drums.

### Art No. 4181

Capacity	Art No.	Flow Rate	Air consumption
16-18 Kg.	4119	0.78 Kg./Min	115 L/Min.
20-30 Kg.	4121	0.78 Kg./Min	115 L/Min.
50-60 Kg.	4161	0.78 Kg./Min	115 L/Min.
180 Kg.	4181	0.78 Kg./Min	115 L/Min.

**NOTE:** Pumps are available for high Volume upto 10.5 Kg/Min. Dispensing Grease at short Distance.





# ★★★★★ REAL HYDROFIT & CO.®

SPLTS: HOSE REEL - SPRING BALANCER - HYDRAULIC HOSES & FITTINGS

## PNEUMATIC OIL, GREASE PUMPS & GUNS AIR OPERATED OIL PUMPS

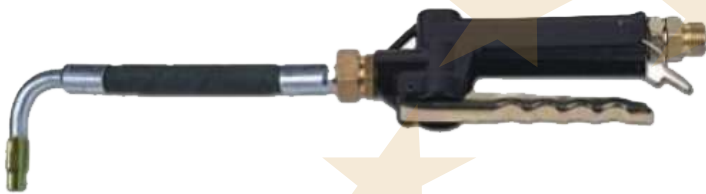

Oil Gun With Flexible Rubber Pipe



Oil Gun With Digital Meter Display



Oil Gun With C.S. Pipe

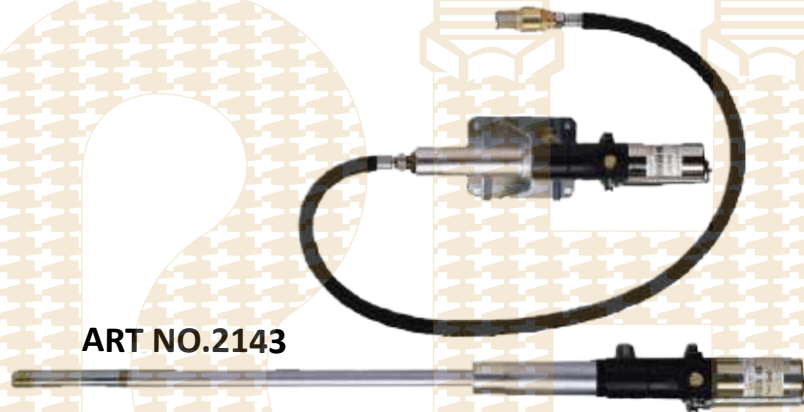

ART NO.2143

Pneumatic Pumps for Low, Medium & High Volume low viscosity oil dispensing at short distance, Output Pressure upto 21 bar at Min.2- Max.8 bar Air Pressure, Compression Ration 1:1, 3:1 & 5:1, Pumps available for Drums. Flow rate at upto 48 Ltr./min.

Art No. 4181

Drum Type	< 20 Mt Dis.	> 20 Mt Dis.	> 100 Mt Dis.
50 Ltr.	2143	2130	2135
200 Ltr.	2120 - 2140	2120 - 2173	2125 - 2175
1000 Ltr.	2120 130	2120130	2125130



sales@realhydrofit.com  
reohydesales@gmail.com



www.realhydrofit.com



9869078630, 9167921882  
91 22 66573951/52/53, 23717488



# REAL HYDROFIT & CO.®

SPLTS: HOSE REEL - SPRING BALANCER - HYDRAULIC HOSES & FITTINGS

## SPRING REWIND FUEL REEL

### TYPE AV8000

Suitable for 3/4" I.D. & 1" I.D. Fuel Hose

### CONSTRUCTION

- Dual stand heavy-duty steel stand.
- All materials is carbon steel as standard (Stainless hose reels materials are available upon requested)
- High-Quality Spring for Long-life of Coil spring, SS ratchet spring & non-corrosive ratchet.
- Standard hose reel Swivel inlet: 90° in stainless steel with 1" BSP F thread.
- Standard hose reel outlet: 1" BSP F thread.
- Full-Flow Shaft and Swivel Rotary to Maximize Fluid flow with minimum pressure drop for faster fills.
- Hose reel inlet, outlet & shat assembly in stainless steel other material upon request.
- Multi-Position Lock Ratchet Secures Hose at desired length.
- 1 piece forged shaft assembly.
- Standard working pressure upto 600 psi
- 2 Years manufacturers waranty.

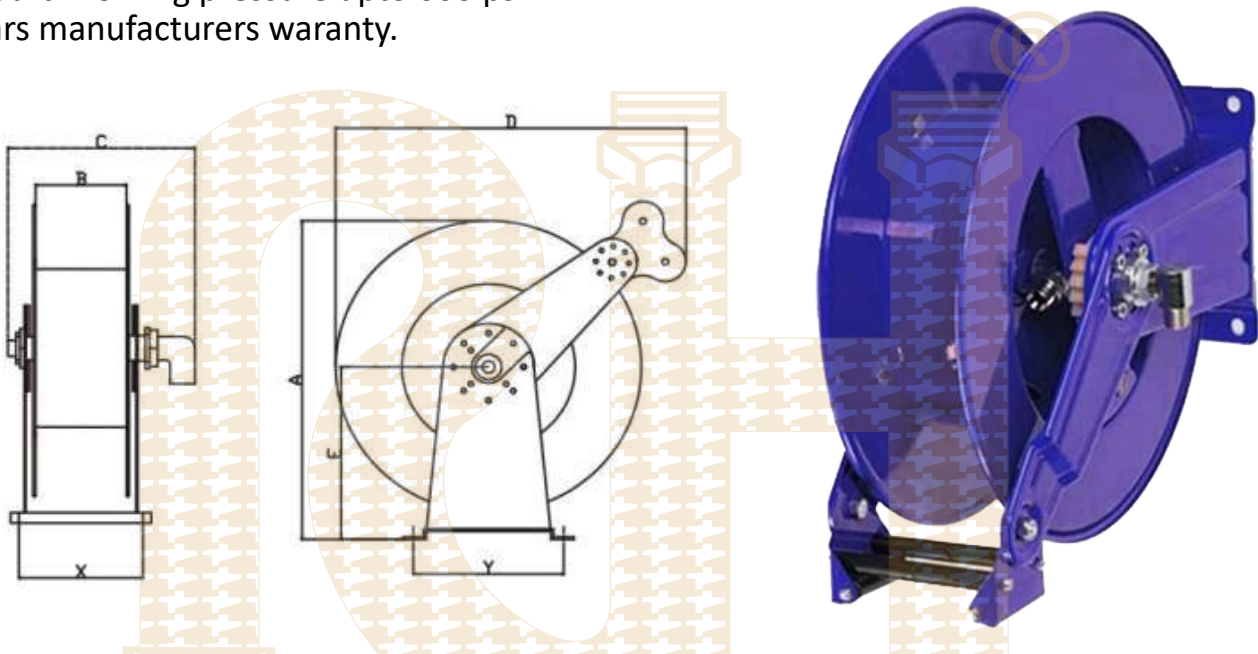

Model No.	Hose Size & Length			Net Wt.	REEL DIMENSION						
	I.D.	19 mm	25 mm		A	B	C	D	E	X	Y
	O.D.	33 mm	40 mm								
AV1910-2508		10 mtr	8 mtr	572	130	300	548	305	150	280	
AV1915-2510		15 mtr	10 mtr	572	170	335	548	305	175	280	
AV1920-2515		20 mtr	15 mtr	572	170	335	548	305	175	280	

**NOTICE:** A flexible connector must be used between the inlet pipe and the inlet swivel joint.

- Reel Dimension are subject to change.
- X & Y Indicates Mounting holes.





# REAL HYDROFIT & CO.®

SPLTS: HOSE REEL - SPRING BALANCER - HYDRAULIC HOSES & FITTINGS

## MANUAL OR POWER REWIND HOSE REEL

### TYPE AV1

Suitable for 1" I.D. Fuel Hose

### CONSTRUCTION

- Industrial heavy-duty steel frame.
- Hose reel can be used either manual hand gear-driven or with an electric dc, hydraulic motor.
- Motorized hose reel supplied with chain & sprocket with pinion brake.
- Standard hose reel Swivel inlet: 900 in stainless steel with 1" BSP F thread.
- Standard hose reel outlet: 1" BSP F thread.
- Hose reel inlet, outlet & shaft assembly in STAINLESS STEEL.
- Single piece forged shaft assembly.
- Standard working pressure upto 1000 psi

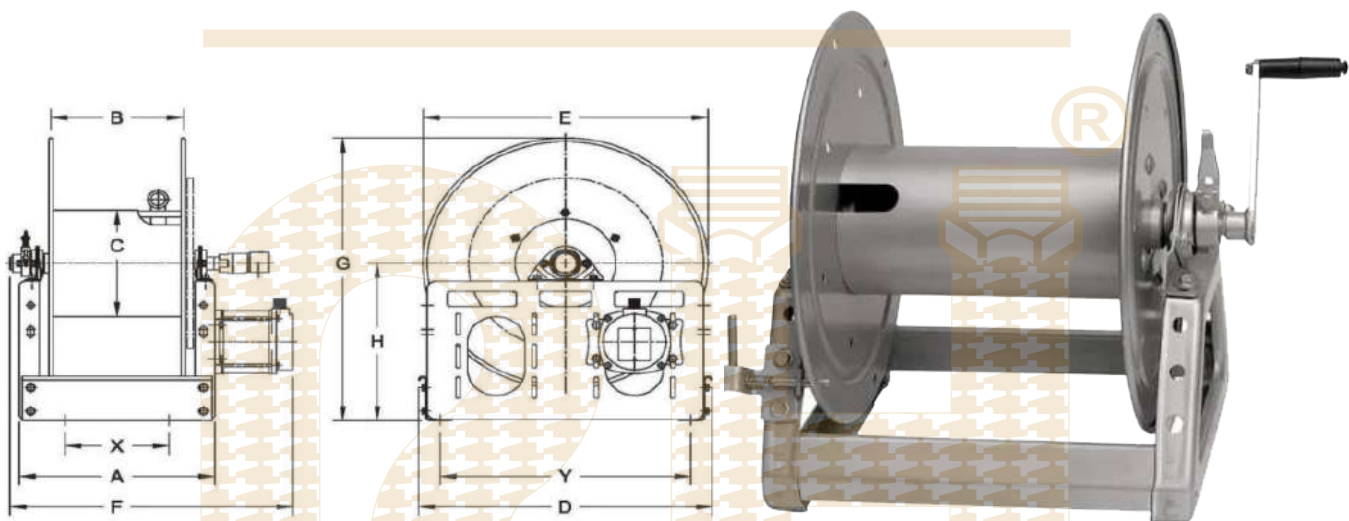

Model No. For Manual Rewind	Model No. For Motor Rewind	Hose Size & Length		Net Wt.	REEL DIMENSION										
		I.D.	25 mm		A	B	C	D	E	F	G	H	X	Y	
		O.D.	40 mm												
AV-0120-MR	AV-0120-MR		18 mtr	330	195	275		635	520	723	395	195	545		
AV-0130-MR	AV-0130-MR		30 mtr	390	255	275		635	580	723	395	255	545		
AV-0140-MR	AV-0140-MR		40 mtr	500	365	275		635	690	723	395	365	545		
AV-0150-MR	AV-0150-MR		50 mtr	570	435	275		635	760	723	395	435	545		

**NOTICE:** A flexible connector must be used between the inlet pipe and the inlet swivel joint.

- Reel Dimension are subject to change.
- X & Y Indicates Mounting holes.
- On Request Reel can be Supplied with other diameter & Length of hoses.



sales@realhydrofit.com  
reohydesales@gmail.com



www.realhydrofit.com



9869078630, 9167921882  
91 22 66573951/52/53, 23717488



# ★★★★★ REAL HYDROFIT & CO.®

SPLTS: HOSE REEL - SPRING BALANCER - HYDRAULIC HOSES & FITTINGS

## SPRING REWIND AIR HOSE REEL

### Auto Rewind Air Hose Reel ( Sheet Metal Series )



Art No. 2000



Swivel Bracket  
for Hose Reel



Art No.	Model No.	Hose Size		Max. Tube Length	Max. Pressure	Mounting Option		M.O.C
		ID MM	OD MM			Hook	Ceiling	
2000	AHR 2440	5.5	8	8 Mtr	10 Kg.	Yes	No	C.S
3000	AHR 2445	5.5	8	15 Mtr	10 Kg.	Yes	No	C.S
3000	AHR 2450	5.5	8	20 Mtr	10 Kg.	Yes	No	C.S
2000	AHR 2460	8	12	4.5 Mtr	10 Kg.	Yes	No	C.S
3000	AHR 2465	8	12	8 Mtr	10 Kg.	Yes	No	C.S
3000	AHR 2470	8	12	10 Mtr	10 Kg.	Yes	No	C.S
3000	AHR 2475	8	12	15 Mtr	10 Kg.	No	Yes	C.S
3000	AHR 2480	8	12	20 Mtr	10 Kg.	No	Yes	C.S
3000	AHR 2585	10	14	10 Mtr	8 Kg.	No	Yes	C.S
3000	AHR 2590	10	14	15 Mtr	8 Kg.	No	Yes	C.S
3000	AHR 2500	10	14	20 Mtr	8 Kg.	No	Yes	C.S
3000	AHR 2510	12	16	10 Mtr	8 Kg.	No	Yes	C.S
3000	AHR 2515	12	16	15 Mtr	8 Kg.	No	Yes	C.S

### Auto Rewind Air Hose Reel ( Plastic Series )



Art No.	Model No.	Hose Size		Max. Tube Length	Max. Pressure	M.O.C
		ID MM	OD MM			
9200/6	RH 92006	6	8	6.5 Mtr	12 Kg.	Plastic
820/6	RH 82006	6	8	11 Mtr	15 Kg.	Plastic
820/8	RH 82008	8	12	10 Mtr	15 Kg.	Plastic
815/8	RH 81508	8	12	16 Mtr	15 Kg.	Plastic
815/10	RH 81510	10	14	16 Mtr	15 Kg.	Plastic
711/L	RH 711L	12	16	16 Mtr	10 Kg.	Plastic



# REAL HYDROFIT & CO.®

SPLTS: HOSE REEL - SPRING BALANCER - HYDRAULIC HOSES & FITTINGS

## SPRING REWIND STATIC DISCHARGE REEL

TYPE AV3000

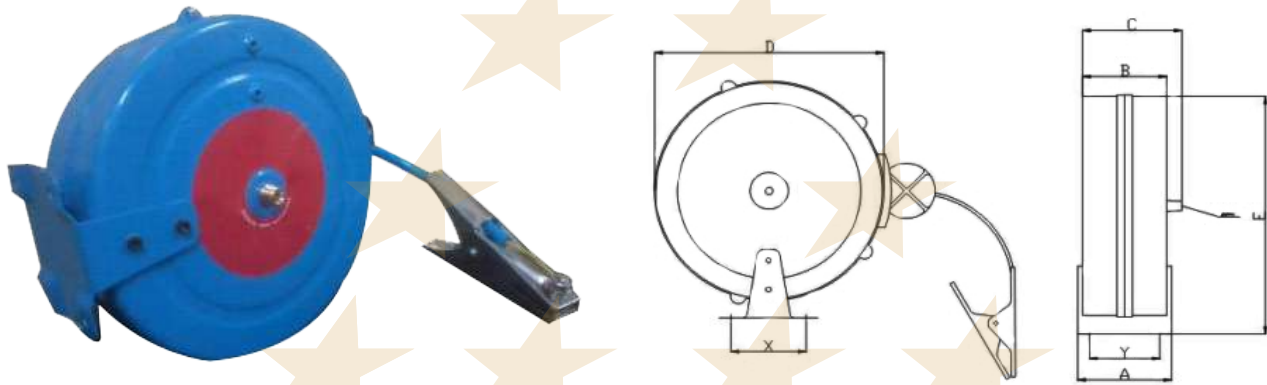

Closed & Compact model reels are more suitable for storage of static grounding cable with quick payout and automatic spring rewind. Designed for safe and reliable grounding of vehicles, aircraft, and other equipment requiring static bonding. Reels are manufactured with sheet metal. These reels are standard supplied with 10,15, 20, 25 or 30 Mtr. of Yellow / Red PVC coated galvanised / SS steel / Copper cables. Finished in a Blue Colour powder coating for all models. It comes with latching lock of cable at 500mm length.

### FEATURES

- Fully automatic spring rewind
  - Non-sparking latchet
- Standard 4mm stainless steel wire with pvc coated 7x7 standard
  - 100 amp grounding clamp
- Electrical Resistance - Max 10 Ohms between damp and mounting base.
  - Metal housing with MIL grade blue colour powder coated (other colour available on request)

### APPLICATION

- Fuel tank loading - unloading static grounding
  - Airplane fuel filling static grounding
  - Utility vehicle static grounding
    - Maintenance shop
- Any place where static might build up.

Model No.	Cable Length	Net Wt.	REEL DIMENSION						
			A	B	C	D	E	X	Y
RH SDR-10 CS	10 mtr		120	96	115	290	300	70	58
RH SDR-15 CS	15 mtr		120	96	115	290	300	70	58
RH SDR-20 CS	20 mtr		135	106	125	325	335	85	100
RH SDR-25 CS	25 mtr		135	106	125	325	335	85	100
RH SDR-30 CS	30 mtr		135	106	125	325	335	85	100



sales@realhydrofit.com  
reohydesales@gmail.com



www.realhydrofit.com



9869078630, 9167921882  
91 22 66573951/52/53, 23717488



# REAL HYDROFIT & CO.®

SPLTS: HOSE REEL - SPRING BALANCER - HYDRAULIC HOSES & FITTINGS

## SPRING REWIND CABLE REEL

### CABLE REEL WITH LAMPS

#### Reel Features

- Auto Rewind Cable Reels for wall mounting equipped with Lamp.
- Available in 2 Version with Transformer & without Transformer.
- Structural elements of cable reel in Shock resistant
- Plastic Material.
- Ratchet lock.
- Wiping contacts with collector ring & brushes.



Art No. 5907



Art No. 5908

Art No.	Model No.	Description	Length	Transfo. Feature	Cable Type	Max. Voltage	Max. Watt Bulb
5907/AM8	RH-5907 AM8	Cable reel with Fluo. Lamp AM8 230V	15.5 (14+1.5)	No	H05 RN-F	230 V	11 W
5907/328	RH-5907 328	Cable reel with Fluo. Lamp 230V	15.5 (14+1.5)	No	H05 RN-F	230 V	11 W
5907/329	RH-5907 329	Cable reel with LED Lamp 230V	15.5 (14+1.5)	No	H05 RN-F	230 V	30 LED
5908/AM8	RH-5908 AM8	Cable reel with Transfo. + Lamp AM8 24V	15.5 (14+1.5)	Input: 230, Output: 24V	H05 RN-F	230 V	11 W
5908/328	RH-5908 328	Cable reel with Transfo. + Lamp 328 24V	15.5 (14+1.5)	Input: 230, Output: 24V	H05 RN-F	230 V	11 W
5908/329	RH-5908 329 24V	Cable reel with Transfo. + LED 329 24V	15.5 (14+1.5)	Input: 230, Output: 24V	H05 RN-F	230 V	30 LED

### CABLE REEL

#### Reel Features

- Shock Resistant Plastic External Case.
- Ratchet Lock every 50 cm, Easily removed if constant traction of cable is required. Double earth Contact.
- Thermal protector Against overload Collector insulation Power 2, 5 Kv.
- Slip Ring with Brass rings & brushes.
- Available both with PVC & Rubber Cable



Art No. 605



Art No. 4315

Art No.	Model No.	No. Of Conductor	Conductor Sec.	Length	Cable Diameter	Voltage Input	Thermal Protector	Max. Voltage	Cable Type
9004	RH 9004	3 G	1.5 MM	5+1	8.5 MM	230 V	Yes	500 A.C	H05VV-F
5827/XF	RH 5827	3 G	1.5 MM	10+1.5	8.5 MM	230 V	Yes	500 A.C	H05VV-F
4315/RNF	RH 4315	3 G	1.5 MM	14+1	8.5 MM	230 V	Yes	500 A.C	H05VV-F
6328	RH 6328	3 G	1.5 MM	10+0.9	8.5 MM	230 V	Yes	500 A.C	H05VV-F
605/CR	RH 605	3 G	1.5 MM	15+1.5	8.5 MM	230 V	Yes	500 A.C	H05VV-F
6252/CR	RH 6252	3 G	1.5 MM	25+1.5	8.5 MM	230 V	Yes	500 A.C	H07RV-F





# ★★★★★ REAL HYDROFIT & CO.®

SPLTS: HOSE REEL - SPRING BALANCER - HYDRAULIC HOSES & FITTINGS

## HEAVY DUTY CABLE REELS

### ARC WELDING REEL (AWR)

Auto Rewind Arc Welding Reel (AWR) provides a quick connection to your welder. In Heavy duty working place using Co2 welder like machinery assembly AWR is very efficient by preventing hazardous & reducing fatigues of workers when extending & retrieving heavy cable also economical by making life of cable longer. Reels are available in manual driven and upto 400 AMPS.

Art No.	Model No.	Cable Specification	Length. (Mtr.)
2320	RH-2320	25 SQ.MM X 1 C X W/H	upto 30
2320	RH-3920	35 SQ.MM X 1 C X W/H	upto 30
2320	RH-7120	70 SQ.MM X 1 C X W/H	upto 20
2320	RH-9115	95 SQ.MM X 1 C X W/H	upto 15



Art No. 2320

### AUTO REWIND CABLE REEL WITH SLIP RING

Auto Rewind Cable Reel ideal for small diameter cable & cable length upto 50 Meters.

#### Features:

- Adjustable cable bumpers allow varying cable length outside the reel
- Latch mechanism guarantees de-reeling of cable that desired length.
- Constant tension reels available.
- Varying guide arm positions allow floor, wall, ceiling or any custom mount.
- Weather-proofed spring motor gasket ensure long life.
- Nylon guide roller eliminate cable pinching and reduce drag.



### CABLE REEL FOR BATTERY CHARGING

Metres of coiled cable	Art.	Power	Cable Reel IP-Code	Nominal Voltage	Cable Type
6m (4.5+1.5)	4216	30 A	IP42	MAX 48V	2x16 mm <sup>2</sup> H05 VV-F
9m (7+2)	6216	30 A	IP42	MAX 48V	2x16 mm <sup>2</sup> H05 VV-F



### TROLLEY FOR SPRING BALANCER

Model No.	Capacity	Weight
RH-T-50	100 kg	-
RH-T-100	250 kg	-
RH-T-200	500 kg	-











# REAL HYDROFIT & CO.®



SPLTS: HOSE REEL - SPRING BALANCER - HYDRAULIC HOSES & FITTINGS

## IMPACT SOCKET & ACCESSORIES

				
Standard Sockets Hex		Impact Deep Sockets Hex		Impact Extension Bars
Sq. Drive	Socket Wrench A/F Size	Size	OAL (MM)	
3/8"	6MM-24MM (METRIC), 1/4" -1"(SAE)	3/8"	75,100,125,150,200,250,300	
1/2"	8MM-32MM (METRIC), 3/8" -1 1/4"(SAE)	1/2"	75,100,125,150,200,250,300	
3/4"	19MM-80MM (METRIC), 9/16" -3"(SAE)	3/4"	75,125,175,210,250,330,430	
1"	27MM-85MM (METRIC), 1 1/16" - 3 1/2"(SAE)	1"	100,125,150,180,	
1 1/2"	36MM-120MM (METRIC), 1 3/8" -5"(SAE)	-	200,250,330,400	
2 1/2"	60MM-180MM (METRIC), 2 1/4" -6 1/4"(SAE)	1 1/2"	150,200,300,400,500,750	

Size not mention above also available on request.

								
Square Drive Adaptors				Universal Joint		Allen Head		
Size	OAL (MM)	Size	OAL (MM)	Size	OAL (MM)	Size	Hex A/F	Length
3/8" F X 1/2" M	35	3/4" F X 1" M	64	3/8"	52	3/8"	4	100
3/8" F X 3/8" M	32	1" F X 3/4" M	70	1/2"	68	1/2"	5	100
1/2" F X 3/8" M	40	1" F X 1" M	75	3/4"	99	3/4"	10	100
1/2" F X 3/4" M	50	1" F X 1 1/2" M	75	1"	125	1"	15	100
1/2" F X 1/2" M	40	1 1/2" F X 1" M	100					
3/4" F X 1/2" M	56	1 1/2" F X 1/2" M	105					
3/4" F X 3/4" M	60							

		
<b>Slugging Wrenches</b>	<b>Mechanical Torque Wrenches</b>	<b>Mechanical Torque Multiplier</b>
<p><b>Available</b></p> <p>Ring Type, Open Type, Offset Type</p> <p><b>Size</b></p> <p>32mm - 115mm (1 1/4" - 3 1/2")</p>	<p><b>Capacity</b></p> <p>170 Kg/M to 5000 Kg/M</p> <p>0.3 Kg/M to 275 Kg/M</p>	<p><b>Capacity:</b></p> <p>170 Kg/M to 5000 Kg/M</p> <p><b>Rotation</b></p> <p>1:5, 1:25, 1:75</p>









# ★★★★★ REAL HYDROFIT & CO.®

SPLTS: HOSE REEL - SPRING BALANCER - HYDRAULIC HOSES & FITTINGS

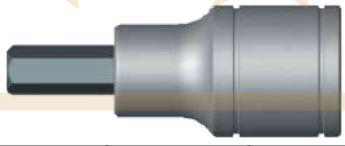

## BIT HOLDER & INSERT BITS

For Screwdriver Application With Impact Wrenchers

		
<b>Size:</b> 3/8" <b>A/F:</b> 8mm - 19mm <b>Length:</b> 150mm	<b>Size:</b> 3/8" Square Drive X 1/4" Hex 1/2" Square Drive X 1/4" Hex	<b>Size:</b> 3/8" Square Drive X 1/4" Hex
<b>Extension Socket, 3/8" Sq.</b>	<b>Adaptors-Quick Change Type</b>	<b>Magnetic Insert Bit Holder</b>

																													
<table border="1"> <thead> <tr> <th>Model No.</th> <th>Length(L)</th> <th>Size</th> </tr> </thead> <tbody> <tr> <td>1873</td> <td>30mm</td> <td>H3</td> </tr> <tr> <td>1874</td> <td>30mm</td> <td>H4</td> </tr> </tbody> </table> <p style="text-align: center;">Size Available upto H8</p>	Model No.	Length(L)	Size	1873	30mm	H3	1874	30mm	H4	<table border="1"> <thead> <tr> <th>Model No.</th> <th>Length(L)</th> <th>Size</th> </tr> </thead> <tbody> <tr> <td>1920</td> <td>50mm</td> <td>H4</td> </tr> <tr> <td>1921</td> <td>50mm</td> <td>H5</td> </tr> </tbody> </table> <p style="text-align: center;">Size Available upto H10 &amp; (L)-100mm</p>	Model No.	Length(L)	Size	1920	50mm	H4	1921	50mm	H5	<table border="1"> <thead> <tr> <th>Model No.</th> <th>Length(L)</th> <th>Size</th> </tr> </thead> <tbody> <tr> <td>1993</td> <td>60mm</td> <td>H4</td> </tr> <tr> <td>1994</td> <td>60mm</td> <td>H5</td> </tr> </tbody> </table> <p style="text-align: center;">Size Available upto H19 &amp; (L)-140mm</p>	Model No.	Length(L)	Size	1993	60mm	H4	1994	60mm	H5
Model No.	Length(L)	Size																											
1873	30mm	H3																											
1874	30mm	H4																											
Model No.	Length(L)	Size																											
1920	50mm	H4																											
1921	50mm	H5																											
Model No.	Length(L)	Size																											
1993	60mm	H4																											
1994	60mm	H5																											
<b>1/4" Hex Socket Bit</b>	<b>3/8" Hex Socket Bit</b>	<b>1/2" Hex Socket Bit</b>																											

Suitable For Impact Wrench

																									
<table border="1"> <thead> <tr> <th>Length</th> <th>Blade Thickness</th> <th>Bit Body Dia.</th> </tr> </thead> <tbody> <tr> <td>69.8</td> <td>0.9</td> <td>6.35</td> </tr> <tr> <td>69.8</td> <td>1.17</td> <td>7.92</td> </tr> <tr> <td>69.8</td> <td>1.27</td> <td>9.14</td> </tr> </tbody> </table>	Length	Blade Thickness	Bit Body Dia.	69.8	0.9	6.35	69.8	1.17	7.92	69.8	1.27	9.14	<table border="1"> <thead> <tr> <th>Length</th> <th>Blade Thickness</th> <th>Bit Body Dia.</th> </tr> </thead> <tbody> <tr> <td>69.8</td> <td>1</td> <td>4.7</td> </tr> <tr> <td>69.8</td> <td>2</td> <td>4.7</td> </tr> <tr> <td>69.8</td> <td>3</td> <td>4.7</td> </tr> </tbody> </table>	Length	Blade Thickness	Bit Body Dia.	69.8	1	4.7	69.8	2	4.7	69.8	3	4.7
Length	Blade Thickness	Bit Body Dia.																							
69.8	0.9	6.35																							
69.8	1.17	7.92																							
69.8	1.27	9.14																							
Length	Blade Thickness	Bit Body Dia.																							
69.8	1	4.7																							
69.8	2	4.7																							
69.8	3	4.7																							

For Use With Magnetic Insert Bit Holder

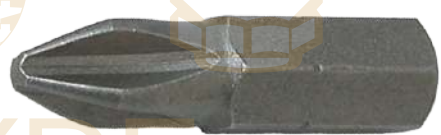
																						
<table border="1"> <thead> <tr> <th>Length</th> <th>Size</th> <th>Quantity Per Packet</th> </tr> </thead> <tbody> <tr> <td>25</td> <td>1.0 - 6.0</td> <td>5</td> </tr> <tr> <td>25</td> <td>1.2 - 6.5</td> <td>5</td> </tr> </tbody> </table>	Length	Size	Quantity Per Packet	25	1.0 - 6.0	5	25	1.2 - 6.5	5	<table border="1"> <thead> <tr> <th>Length</th> <th>Size</th> <th>Quantity Per Packet</th> </tr> </thead> <tbody> <tr> <td>25</td> <td>PH1</td> <td>5</td> </tr> <tr> <td>25</td> <td>PH2</td> <td>5</td> </tr> <tr> <td>25</td> <td>PH3</td> <td>5</td> </tr> </tbody> </table>	Length	Size	Quantity Per Packet	25	PH1	5	25	PH2	5	25	PH3	5
Length	Size	Quantity Per Packet																				
25	1.0 - 6.0	5																				
25	1.2 - 6.5	5																				
Length	Size	Quantity Per Packet																				
25	PH1	5																				
25	PH2	5																				
25	PH3	5																				
<b>Slotted Bit - Impact Type</b>	<b>Phillips Bit - Impact Type</b>																					



# ★★★★★ REAL HYDROFIT & CO.®

SPLTS: HOSE REEL - SPRING BALANCER - HYDRAULIC HOSES & FITTINGS

## ONE - TOUCH PNEUMATIC Q.R.C



Model No.	SF	SM	SH	SN	PF	PM	PH	PN
1/4" (20)	20SF	20SM	20SM	50-60SN	20PF	20PM	20PH	50-60 PN
3/8" (30)	30SF	30SM	30SM	80SN	30PF	30PM	30PH	80PN
1/2" (40)	40SF	40SM	40SM	110SN	40PF	40PM	40PH	110PN

HI-COUPER Q.R.C. ( C.S. / S.S. / BRASS )

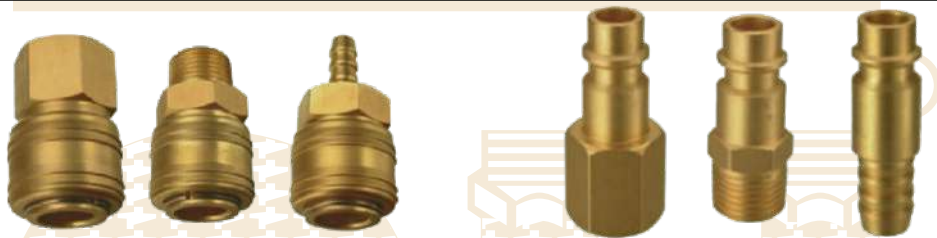

Model No.	SF	SM	SH	SN	PF	PM	PH	PN
1/4" (20)	20SF	20SM	20SH	50SN	20PF	20PM	20PH	50PN
3/8" (30)	30SF	30SM	30SH	80SN	30PF	30PM	30PH	80PN
1/2" (40)	40SF	40SM	40SH	110SN	40PF	40PM	40PH	110PN

RECTUS TYPE Q.R.C ( PNEUMATIC BRASS )

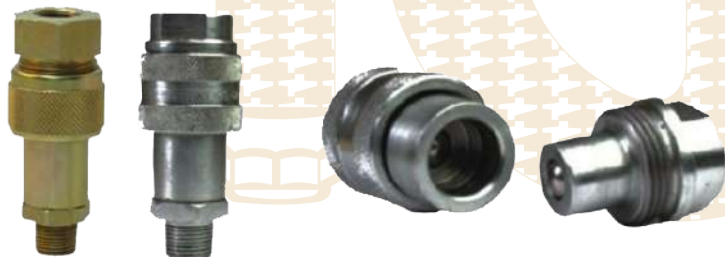

Size	Plug	Socket	Set	M.O.C
G 1/4"	2PF	2SF	2PS	C.S
G 3/8"	3PF	3SF	3PS	C.S

SCREW TYPE HYDRAULIC Q.R.C ( BALL TYPE )

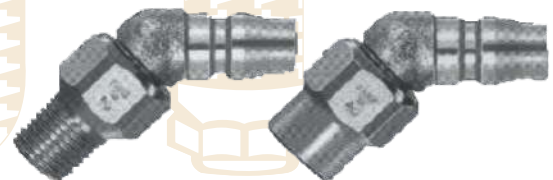

Size	Male	Female	M.O.C
G 1/4"	RP 20	RF 20	C.S
G 3/8"	RP 30	RF 30	C.S

ROTARY PLUG ( 360° SWIVEL )





# ★★★★★ REAL HYDROFIT & CO.®

SPLTS: HOSE REEL - SPRING BALANCER - HYDRAULIC HOSES & FITTINGS

## HYDRAULIC Q.R.C



**DOUBLE CHECK VALVE Q.R.C**

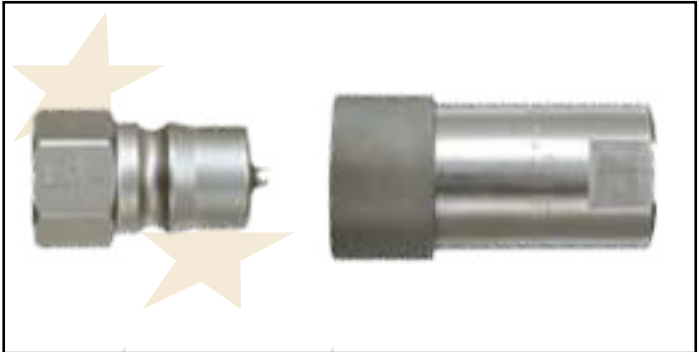

**HSP Q.R.C**

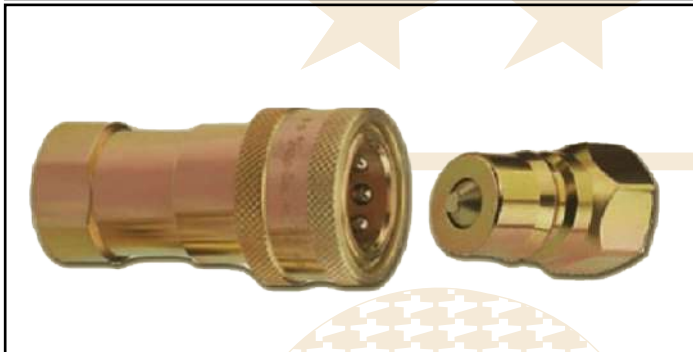

**SERIES ISO A - 7241**

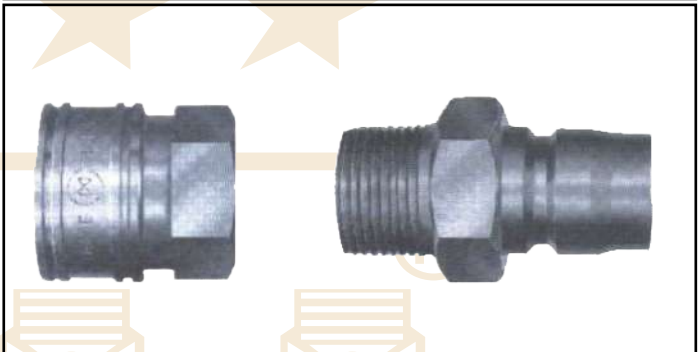

**STRAIGHT THROUGH Q.R.C**

Size	Plug	Socket	Set	M.O.C
1/4"	2PF	2SF	2SP	C.S / S.S / Brass
3/8"	3PF	3SF	3SP	C.S / S.S / Brass
1/2"	4PF	4SF	4SP	C.S / S.S / Brass
3/4"	6PF	6SF	6SP	C.S / S.S / Brass
1"	8PF	8SF	8SP	C.S / S.S / Brass

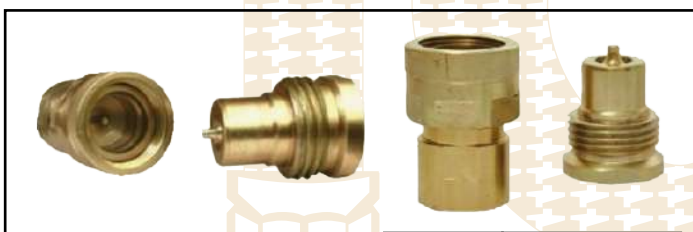

Size	Plug	Socket	Set	M.O.C
1/4"	2PF	2SF	2SP	C.S / S.S
3/8"	3PF	3SF	3SP	C.S / S.S
1/2"	4PF	4SF	4SP	C.S / S.S
3/4"	6PF	6SF	6SP	C.S / S.S
1"	8PF	8SF	8SP	C.S / S.S

**SERIES HPSC**



Size	Plug	Socket	Set	M.O.C
1/4"	2PF	2SF	2SP	C.S
3/8"	3PF	3SF	3SP	C.S
1/2"	4PF	4SF	4SP	C.S
3/4"	6PF	6SF	6SP	C.S
1"	8PF	8SF	8SP	C.S

**FLAT FACED COUPLER**

**\*NOTE:** We are manufacturing above model Q.R.C upto 2". For application Agriculture & Industrial Use.



sales@realhydrofit.com  
reohydesales@gmail.com



www.realhydrofit.com



9869078630, 9167921882  
91 22 66573951/52/53, 23717488



# ★★★★★ REAL HYDROFIT & CO.®

SPLTS: HOSE REEL - SPRING BALANCER - HYDRAULIC HOSES & FITTINGS

## GUN & PNEUMATIC ACCESSORICES



Blow Gun, Nickel Plated Aluminium Body  
Size: 1/4" BSP

**AIR BLOW GUN**



Water Gun In Aluminium & Brass  
Size: 1/2" BSP

**HIGH PRESSURE WATER GUN**



Spray Gun  
Size: 1/2" BSP

**HIGH PRESSURE SPRAY GUN**



Size: 1/4", 1/2", 3/4", 1", 2" BSP

**FILTER REGULATOR LUBRICATOR (FRL)**



As Per Customer Requirement

**PU - LEADER HOSE**



<b>Tube OD (mm)</b>	8	12	14	16
<b>Recoil Length (Mtr)</b>	3	5	7.5	10

Other size of PU Tube & Recoil Hose are available as per customer requirement.

**PU TUBE & RECOILED HOSE**



<b>Tube ID</b>	6	8	10	13
<b>OD</b>	8	12	14	18

Tube w/p : 20 kg

**PU - BRAIDED TUBE**



The manifold can design be spoke at the request of the customer and supply them already assembly. The manifolds can be manufactured with both systems.

**ALUMINIUM MANIFOLD**



Tyre Inflating Gun with Gauge 60mm, Double scale 0-10 Bar with Pressure Release button, Flip on connector & 300, 1000mm. Rubber hose, Size: 1/4" BSP.

**TIRE INFLATUON GUN**





# ★★★★★ REAL HYDROFIT & CO.®

SPLTS: HOSE REEL - SPRING BALANCER - HYDRAULIC HOSES & FITTINGS

## TOOL TROLLEY & ACCESSORIES



**TWO WHEELER POST LIFT**



**TOOL TROLLEY**



**CONTAINER & TANK SERVICE**



**PNEUMATIC PANEL BOARD  
& HOSE REELS HANGERS**



**PNEUMATIC OIL  
DISTRIBUTION UNIT**

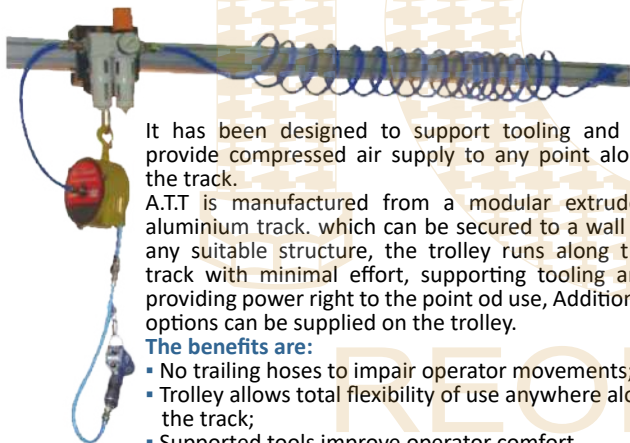

It has been designed to support tooling and to provide compressed air supply to any point along the track.

A.T.T. is manufactured from a modular extruded aluminium track, which can be secured to a wall or any suitable structure, the trolley runs along the track with minimal effort, supporting tooling and providing power right to the point of use. Additional options can be supplied on the trolley.

**The benefits are:**

- No trailing hoses to impair operator movements;
- Trolley allows total flexibility of use anywhere along the track;
- Supported tools improve operator comfort.

Oil Transfer unit and digital meter for 208 l drums, hose reel included, with special wheeled trolley suitable for rough surfaces, composed by:

- Pneumatic pump R. 3:1
- Pump adaptor for drums
- 4 wheels trolley with grid
- Flexible rubber hose L.1 mt 1/2"
- Automatic hose reel L. 10 mt, 1/2" with hose
- Digital oil meter
- FR regulator with condensate drainage end gauge



sales@realhydrofit.com  
reohydesales@gmail.com



www.realhydrofit.com



9869078630, 9167921882  
91 22 66573951/52/53, 23717488



# REAL HYDROFIT & CO.®

SPLTS: HOSE REEL - SPRING BALANCER - HYDRAULIC HOSES & FITTINGS

**CERTIFICATE**  
This is to certify that  
**REAL HYDROFIT & CO.**  
at  
**514/A, SUSSEX INDUSTRIAL ESTATE, D.K. CROSS ROAD,  
BYCULLA (E), MUMBAI - 400027, MAHARASHTRA, INDIA**

has been independently assessed by VRS  
and found to be meeting the requirements of  
**ISO 9001:2015**  
Quality Management System  
For the following scope  
**MANUFACTURER & STOCKIEST OF ALL TYPES  
FLEXIBLE HOSES & HYDRAULIC FITTINGS**

Date of Certification : 11 October 2021      2nd Surveillance : 10 October 2023  
1st Surveillance : 10 October 2022      Re-certification Due on : 10 October 2024

Certificate No. : 2706SAFV2021

Authorised Signatory

VRS Certification Services Pvt. Ltd.,  
 Plot No. 21, 19/2A, 2nd Floor, (Old No. 1) B, Block, (Old, Block),  
 Vikram Nagar (W), New Delhi - 110019, India  
 Validity of this certificate is subject to regular surveillance visits to the client's premises, as per the terms and conditions of the certificate. No certificate shall be issued without the client's consent.  
 The validity of this certificate can be verified at [www.vrs-certification.com](http://www.vrs-certification.com)  
 Certificate for the purpose of ISO Certification Services Pvt. Ltd. and shall be renewed when demanded.  
 Accredited by: International Accreditation for Certification Bodies (www.iafcbb.com)

**CERTIFICATE**  
This is to certify that  
**REAL HYDROFIT & CO.**  
**514/A, SUSSEX INDUSTRIAL ESTATE, D.K. CROSS ROAD,  
BYCULLA (E), MUMBAI - 400027, MAHARASHTRA, INDIA**

has been independently assessed by VRS  
and found to be meeting the requirements of  
**ISO 9001:2015**  
Quality Management System  
For the following scope  
**MANUFACTURER & STOCKIEST OF ALL TYPES  
FLEXIBLE HOSES & HYDRAULIC FITTINGS.**

Date of Certification : 29 October 2018      2nd Surveillance : 28 October 2020  
1st Surveillance : 28 October 2019      Re-certification Due on : 28 October 2021

Certificate No. : 1809SAFV2018

Authorised Signatory

VRS Certification Services Pvt. Ltd.,  
 Plot No. 21, 19/2A, 2nd Floor, (Old No. 1) B, Block, (Old, Block),  
 Vikram Nagar (W), New Delhi - 110019, India  
 Validity of this certificate is subject to regular surveillance visits to the client's premises, as per the terms and conditions of the certificate. No certificate shall be issued without the client's consent.  
 The validity of this certificate can be verified at [www.vrs-certification.com](http://www.vrs-certification.com)  
 Certificate for the purpose of ISO Certification Services Pvt. Ltd. and shall be renewed when demanded.  
 Accredited by: International Accreditation for Certification Bodies (www.iafcbb.com)

भारत सरकार  
Government of India  
सूक्ष्म, लघु एवं मध्यम उद्यम मंत्रालय  
Ministry of Micro, Small and Medium Enterprises

**UDYAM**  
REGISTRATION CERTIFICATE

Our small hands to make you LARGE

TYPE OF ENTERPRISE	MICRO	MANUFACTURING
<b>UDYAM REGISTRATION NUMBER</b>	UDYAM MH 19-090724	
<b>NAME OF ENTERPRISE</b>	REAL HYDROFIT AND CO.	
<b>NAME OF UNITS</b>		
<b>OFFICIAL ADDRESS OF ENTERPRISE</b>	Part/Plot/Block No. 514/A, 4TH FLOOR Village/Town BYCULLA (E) Road/Street/Lane D.K. CROSS ROAD District THANE State MAHARASHTRA PINCODE 400027	Name of Precinct/Building Block City MUMBAI District THANE State MAHARASHTRA
<b>DATE OF INCORPORATION / REGISTRATION OF ENTERPRISE</b>	29/03/1962	
<b>DATE OF COMMENCEMENT OF PRODUCTION/BUSINESS</b>	29/03/1962	
<b>NATIONAL INDUSTRY CLASSIFICATION CODE(S)</b>	2891 - 2892 - 2893 - 2894 - 2895 - 2896 - 2897 - 2898 - 2899 - 2900 - 2901 - 2902 - 2903 - 2904 - 2905 - 2906 - 2907 - 2908 - 2909 - 2910 - 2911 - 2912 - 2913 - 2914 - 2915 - 2916 - 2917 - 2918 - 2919 - 2920 - 2921 - 2922 - 2923 - 2924 - 2925 - 2926 - 2927 - 2928 - 2929 - 2930 - 2931 - 2932 - 2933 - 2934 - 2935 - 2936 - 2937 - 2938 - 2939 - 2940 - 2941 - 2942 - 2943 - 2944 - 2945 - 2946 - 2947 - 2948 - 2949 - 2950 - 2951 - 2952 - 2953 - 2954 - 2955 - 2956 - 2957 - 2958 - 2959 - 2960 - 2961 - 2962 - 2963 - 2964 - 2965 - 2966 - 2967 - 2968 - 2969 - 2970 - 2971 - 2972 - 2973 - 2974 - 2975 - 2976 - 2977 - 2978 - 2979 - 2980 - 2981 - 2982 - 2983 - 2984 - 2985 - 2986 - 2987 - 2988 - 2989 - 2990 - 2991 - 2992 - 2993 - 2994 - 2995 - 2996 - 2997 - 2998 - 2999 - 3000	2219 - Manufacture of other rubber products 2220 - Manufacture of other plastic products 2221 - Manufacture of other non-metallic mineral products 2222 - Other manufacturing
<b>DATE OF UDYAM REGISTRATION</b>	04/08/2020	

Disclaimer: This is a computer generated statement, no signature required.  
 Printed form: <https://udyamregistration.gov.in>

For any assistance, you may contact:  
 1. DIC      MUMBAI CITY  
 2. MSME-DE      MUMBAI

Visit : [www.msme.gov.in](http://www.msme.gov.in) ; [www.udyamregistration.gov.in](http://www.udyamregistration.gov.in) ; [www.chemtango.com](http://www.chemtango.com)

BE A CHAMPION

with the  
Ministry of  
MSME



# REAL HYDROFIT & CO.®

SPLTS: HOSE REEL - SPRING BALANCER - HYDRAULIC HOSES & FITTINGS

Udyog Aadhaar Memorandum								
1. Aadhaar Number	74236041320							
2. PAN Number	ADUPM382L							
3. Name of Entrepreneur	AAMIR ABDULHUSAN MASTA							
4. Social Category of Entrepreneur	GENERAL							
5. Gender	Male							
6. Physically Handicapped	No							
7. Name of Enterprise	REAL HYDROFIT AND CO							
8. Type of Organization	Proprietary							
9. Location of Plant Details								
SN	Flat/Door/Block No.	Name of Premises/Building Village	Road/Street/ Lane	Area/Locality	City	Pin	State	District
1	UNIT NO.4, GROUND FL	OLD ATLAS MILL COMPOUND	210, REAY ROAD (W)	REAY ROAD	MUMBAI 400010	MAHARASHTRA	MUMBAI CITY	
Official Address of Enterprise		514/A, SUSSEX INDUSTRIAL ESTATE, D.K. CROSS ROAD, BYCULLA (E), MUMBAI						
		District	MUMBAI CITY		State	MAHARASHTRA		PIN 400027
		Mobile No.	9889078630		Email:	sales@realhydrofit.com		
11. Date of commencement		29/03/1992						
12. Previous Registration details-if any		-						
13. Bank Details		IFS Code		UBIN0531626				
		Bank Account:		316201010006101				
14. Major Activity		MANUFACTURING						
SN	NIC 2 Digit	NIC 4 Digit	NIC 5 Digit Code				Activity Type	
1	23	2399	23999 - Manufacture of other non-metallic mineral products n.e.c. (includes asbestos yam and fabric, and articles of asbestos yam and fabric such as clothing, headgear, footwear, cord, string, paper or felt, friction material with a basis of asbestos or other mineral substances or of cellulose including uncounted articles such as friction material; mineral insulating material (slag wool, rockwool and similar mineral wools, extruded vermiculite, expanded clays and similar insulating material); products of glass wool for heat-insulating; articles of asphalt or of similar material (e.g. coal tar pitch), gypsum and articles of other mineral substances)				Manufacturing	
2	32	3290	32909 - Other manufacturing n.e.c. Manufacture of other articles n.e.c.				Manufacturing	
17. Persons employed		21						
18. Investment (Plant & Machinery / Equipments)		50(Rs. In Lakhs)						
19. District Industry Centre		MUMBAI CITY						
<b>Declaration</b> I/We hereby declare that information given above is true to the best of my knowledge. Any information, that may be required to be verified, shall be provided immediately before the concerned authority. My/Our Mobile App (Beta Version) is available now for download. <a href="https://play.google.com/store/apps/details?id=msme.mysme">https://play.google.com/store/apps/details?id=msme.mysme</a>								



**Certificate**

CDG Certification Limited  
certifies that

**Real Hydrofit & Co.**

(Brand Name: Speedway Products)

514/515/A, Sussex Industrial Estate, D.K. Cross Road, Byculla (E),  
Mumbai-400027 Maharashtra / INDIA

Old Atlas Mill Compound, Unit No. 4, Ground Floor 210, Reay Road (W),  
Mumbai-400010 Maharashtra / INDIA

Has established and applies a Quality Management System  
for following scope of activities:

**Manufacturer & Stockist of Flexible Hoses & Hydraulic Fittings**

The Management System of the above organization has been audited and found to be in  
accordance with the requirements of management systems standards detailed below

## ISO 9001 : 2008

Certificate Registration No. CCL/QMS/21335

Originally registered: 28/06/2014 Latest Issue: 28/06/2014 Expiry Date: 22/06/2017

Validity of certificate is subjected to the continued satisfactory operation of the organization's Management System.



Managing Director

This document is issued by the company subject to its general Terms & Conditions of Business for certification services available at [www.cdgcertification.com](http://www.cdgcertification.com). After the date of issuance, audit & surveillance visits are essential. The authority of the document may be limited by any modification or alteration made without the consent of the certifier. The validity of the document is subject to the continued operation of the Management System. The certificate holder shall be responsible for the maintenance of the Management System and shall ensure that the certificate holder is aware of the requirements of the standard. The certificate holder shall be responsible for the maintenance of the Management System and shall ensure that the certificate holder is aware of the requirements of the standard.

CCL  
JAS-ANZ  
IAF

CDG Certification Limited (I), 208, 1st Floor, L.S.C. C Block, CDIA Market, Vile Parle, New Delhi 110019 INDIA.  
T: +91 11 64308622 C: +91 9810000000 W: [www.cdgcertification.com](http://www.cdgcertification.com)



## CERTIFICATE

**Certificate of Compliance**

We confirm that the technical documentation for the below mentioned products according to the Council Directive 97/23/EC Pressure equipment (PED).

Products:

**Industrial Rubber Hoses, Hydraulic Hoses, Marine Industrial Hoses, Gas & Pharmaceutical Hoses, High Temperature Hoses, Bellows, Industrial Fittings, Industrial Valves, Hydraulic Fitting, Fitting Equipments, Quick Release Couplings, Industrial Hose Ends, Industrial Accessories, PTFE Expansion Bellows, Industrial Coupling & Fire Fighting Hose**

Manufactured by company:

**Real Hydrofit & Co.**

514/515/A, Sussex Industrial Estate, D.K. Cross Road, Byculla (E),  
Mumbai-400027 Maharashtra India  
Old Atlas Mill Compound, 210, Reay Road (W), Mumbai-400010  
Maharashtra India

is complying to the applicable essential requirements of Directive 97/23/EC Pressure equipment (PED).

The Regal Quality Registrars Inc. has conducted with successful results the review of the manufacturer's technical documentation of the certified according to above mentioned Directive.

This certificate is issued under the following conditions:

- It applies only to the above referenced set of products mentioned above. The manufacturer is obligated to ensure that all products of the respective model conform to the type assessed by this certificate.
- The Certificate validity is conditioned by the positive results of the surveillance audits.
- The Certificate remains valid until the manufacturing conditions, the quality systems or relevant legislation are changed but until the 20<sup>th</sup> Jul 2017.
- After fulfilling the relevant EU legislation requirements, the manufacturer shall affix to each product of the above referenced models, CE Marking according to the following example:



Certificate No. : CE-3246  
Date of registration : 27<sup>th</sup> Jul 2014  
Date of this certificate : 27<sup>th</sup> Jul 2014  
Date of Expiry : 20<sup>th</sup> Jul 2017



Authorized Signatory  
**Regal Quality Registrars Inc.**

This certificate of conformity based on the evaluation of a sample of the above referenced products, it does not imply an endorsement or approval of the product. The certification body should be informed in technical (or) for any modification or alteration made to the above mentioned product types. The manufacturer is responsible for the product and ensuring that all manufactured products are in compliance with the specifications declared in the technical construction file.

Further clarification regarding the scope of this certificate and the applicability of the management system requirements may be obtained by contacting the registration. Check [www.regalqualityregistrars.co.uk](http://www.regalqualityregistrars.co.uk) for current status of the certificate. Whilst all our work will be completed by carrying out this assessment, RQR's accepts responsibility only for gross given negligence. This certificate remains property of RQR to whom it must be returned upon request.

This Certificate is valid as long as the organization meets RQR's requirements. The status of the certificate may be checked at [www.regalqualityregistrars.co.uk](http://www.regalqualityregistrars.co.uk)

# OUR MORE PRODUCTS

  
**REAL HYDROFIT & CO.**  
SPLITS: FLEXIBLE HOSES - INDUSTRIAL VALVES - HYDRAULIC FITTINGS  
**Composite Hose**





  
[www.realhydrofit.com](http://www.realhydrofit.com)

  
**REAL HYDROFIT & CO.**  
SPLITS: PRESSURE GAUGES - FLEXIBLE HOSES - HYDRAULIC FITTINGS  
**PRESSURE GAUGES**



  
[www.realhydrofit.com](http://www.realhydrofit.com)

  
**REAL HYDROFIT & CO.**  
SPLITS: TUBE-PIPE FITTINGS - FLEXIBLE HOSES - HYDRAULIC FITTINGS  
**TUBES & PIPE FITTINGS**





  
[www.realhydrofit.com](http://www.realhydrofit.com)

  
**REAL HYDROFIT & CO.**  
SPLITS: PP CLAMP - FLEXIBLE HOSES - HYDRAULIC FITTINGS  
**PIPE CLAMPS**



  
[www.realhydrofit.com](http://www.realhydrofit.com)

  
**REAL HYDROFIT & CO.**  
SPLITS: VALVE - FLEXIBLE HOSES - HYDRAULIC FITTINGS  
**INSTRUMENTATION VALVES**



M.O.C:  
 A479 304, A479 316, A182 GRF 316, Monel,  
 Hastelloy, Inconel, Duplex,  
 A choice of PTFE and PEEK are available.

  
[www.realhydrofit.com](http://www.realhydrofit.com)

  
**REAL HYDROFIT & CO.**  
SPLITS: VALVE - FLEXIBLE HOSES - HYDRAULIC FITTINGS  
**COMPLETE RANGE OF ISI & IBR APPROVED VALVES & COCKS**



  
[www.realhydrofit.com](http://www.realhydrofit.com)



sales@realhydrofit.com  
reohydesales@gmail.com



www.realhydrofit.com



9869078630, 9167921882  
91 22 66573951/52/53, 23717488

# OUR MORE PRODUCTS

\*\*\*\*\*  
**REAL HYDROFIT & CO.**  
**Hygienic Hose & Fittings**

IAF CCL CE  
ISO 9001:2008 CERTIFIED COMPANY

[www.realhydrofit.com](http://www.realhydrofit.com)

\*\*\*\*\*  
**REAL HYDROFIT & CO.**  
**industrial hoses**

IAF CCL CE  
ISO 9001:2008 CERTIFIED COMPANY

[www.realhydrofit.com](http://www.realhydrofit.com)

\*\*\*\*\*  
**REAL HYDROFIT & CO.**

**EXPANSION JOINTS**

IAF CCL CE  
ISO 9001:2008 CERTIFIED COMPANY

\*\*\*\*\*  
**REAL HYDROFIT & CO.**  
**Instrumentation and Tube Fittings**  
Imperial and Metric

Specialist in : Low/High Pressure Hydraulic, Air, LPG, CNG, Steam, Chemical, Food Grade Hoses.  
All Types of Industrial, Soften, S.S, Metallic, Corrugated Flexible Hoses, Pressure Gauges & All Types of Fittings.

IAF CCL CE  
ISO 9001:2008 CERTIFIED COMPANY

\*\*\*\*\*  
**REAL HYDROFIT & CO.**

**Rubber Expansion Joint**

IAF CCL CE  
ISO 9001:2008 CERTIFIED COMPANY

\*\*\*\*\*  
**REAL HYDROFIT & CO.**  
**FLANGES & PIPES**

REAL service comes with sincerity and integrity, first - mainly first.

\*\*\*\*\*  
**REAL HYDROFIT & CO.**

**HYDRAULIC - TEMPERATURE  
HOSES & FITTINGS**



[sales@realhydrofit.com](mailto:sales@realhydrofit.com)  
[reohydesales@gmail.com](mailto:reohydesales@gmail.com)



[www.realhydrofit.com](http://www.realhydrofit.com)



9869078630, 9167921882  
91 22 66573951/52/53, 23717488



★★★★★  
**REAL HYDROFIT & CO.**®

SPLTS: HOSE REEL - SPRING BALANCER - HYDRAULIC HOSES & FITTINGS

**514/A, Sussex Industrial Estate, Dadoji Konddev Cross Road,  
Byculla (E), Mumbai- 400027**

☎ **+91-9869078630 / +91-9167921882**

☎ **+91-22-66573951/52/53 / 23717488**

**sales@realhydrofit.com reohydesales@gmail.com**

**www.realhydrofit.com**

**GST NO: 27ADUPM0382L1ZX**